

**SMITH  
& NOBLE**

---

*Rechargeable Motivia®  
Motorization Made Simple*

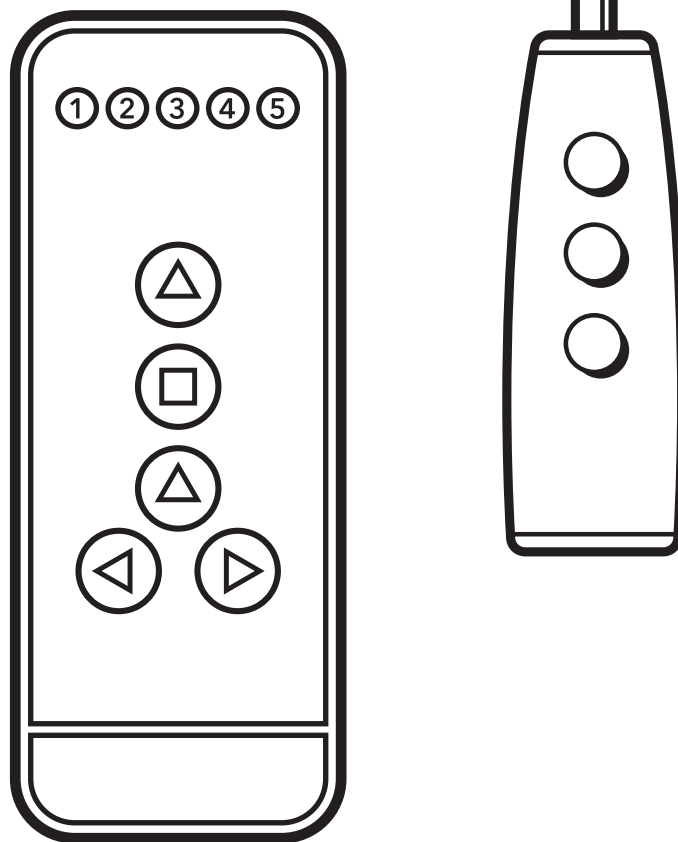

Horizontal Sheer Shadings

## Operate Your Shade with A Motivia™ Multi-Channel Remote

For added protection, your remote control arrived with a protective film on the top. Please remove this film prior to use.

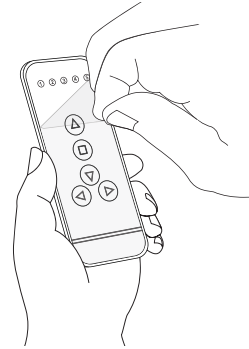

### RAISE AND LOWER THE SHADE

- **STEP 1:** Select a channel using the *Channel* button  
(Channel Display screen will indicate what channel you are on.)
- **STEP 2:** Press *Down* button for 2 seconds to lower the shade or the *Up* button for 2 seconds to raise the shade.
- **STEP 3:** Press the *Stop* button to stop the shade.  
Please note: Factory has set the full closed and open stops on your shade(s).

### OPEN AND CLOSE THE VANES

- **STEP 1:** Select a channel using the *Channel* button.  
(Press right or left side of button to scroll through the channels.)
- **STEP 2:** Lower the shading all the way down, using the *Down* button.
- **STEP 3:** Tapping the *Up* or *Down* button for less than 2 seconds will move the shade in short steps. This allows precise control of the vane open/close position. Holding the *Up* or *Down* button down for more than 2 seconds before releasing will operate the shade in the faster standard speed.

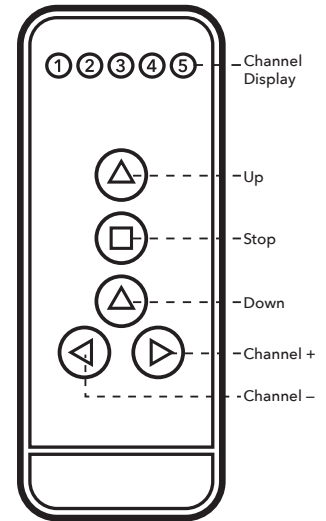

## Setting and Using a Favorite Position

- **STEP 1:** use the *UP* or *DOWN* buttons to position the shade at the desired "favorite" position.
- **STEP 2:** First press and hold the *LIMIT* button on the back of the remote with a small screwdriver or tip of a pen. While holding the *LIMIT* button press and hold the *UP* button. Release both buttons when the shade jogs.
- **STEP 3:** With the shade at either the upper or lower limit, simply press the *STOP* button to bring the shade to the "favorite" position.
- **STEP 4:** To go to the "favorite" position from any other location, make sure the shade has been stopped for at least three seconds before pressing the *STOP* button.

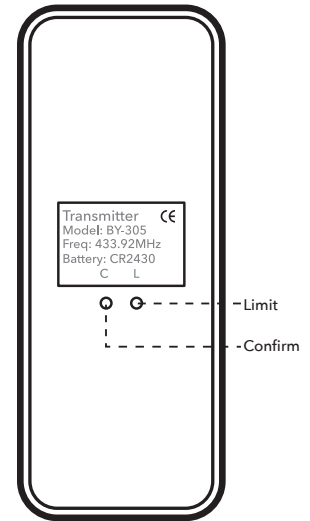

## Change the Factory Programmed Auto Stop Positions

- **STEP 1:** Select the channel you wish to program.  
(If programming more than 1 shade - unplug battery pack of other shades)
- **STEP 2:** Using a small screw driver or the end of a pen, press and hold the *Limit* button for 10 seconds until shade jogs, release the key after the shade jogs.
- **STEP 3:** Press *Down* button to lower the shade.
- **STEP 4:** Press *Stop* button when bottom rail reaches desired length. Adjust length as needed by pressing the *Up* or *Down* button.
- **STEP 5:** Press the *Confirm* button to set the auto stop. The shade will jog.
- **STEP 6:** To set *Upper Limit* (location) repeat Steps 3-5 above using the *Up* button.

### *Operate Your Shade with a Motivia Wand*

Press the **DOWN** or **UP** button to lower or raise the shade.

Press the **STOP/FAVORITE** to stop the shade at the desired position.

To fully raise or lower the shade, simply press the **UP** or **DOWN** button and then release. The shade will automatically stop when it reaches the upper or lower limit. *(If the upper or lower limits are not set at the desired positions, see the Adjust Motor Limits section below)*

**Note:** Upper and lower limits stops are set at the factory. An intermediate, or "favorite" position is not set at the factory. See page 3 for more information.

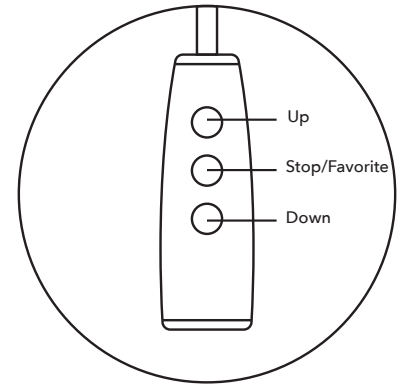

### *Adjust Motor Limits (if desired)*

The Upper and Lower Limits have been set at the factory. If you need to make adjustments to the limits, follow the instructions below.

Press the Settings button on the back of the wand and hold it in until the motor stops beeping. This will clear both the upper and lower factory limits.

- **SET UPPER LIMIT** - Press the *Up* button to get the shade close to the upper limit and then press the *Stop* button to stop the shade.  
Tap the *Up* or *Down* button to move the shade to the desired position.  
To save the location, press the *Settings* button until the motor beeps.
- **SET LOWER LIMIT** - Press the *Down* button to get the shade close to the lower limit and then press the *Stop* button to stop the shade.  
Tap the *Up* or *Down* button to move the shade to the desired position.  
To save the location, press the *Settings* button until the motor beeps.

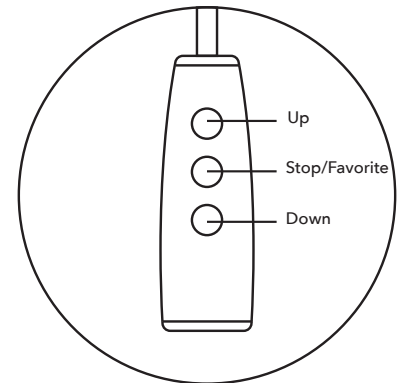
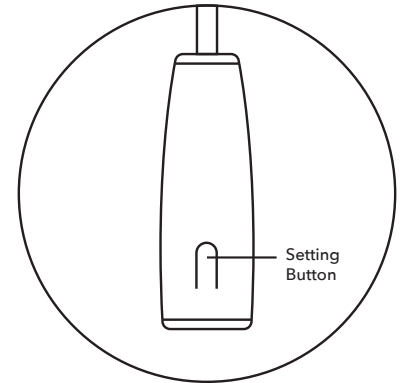

### *Setting and Using a Favorite Position*

Use the **UP** or **DOWN** buttons to position the shade at the desired "favorite" position. First press and hold the **SETTING** button the back of the wand. While holding the **SETTING** button, press and hold the **UP** button. Release both buttons when the shade beeps.

With the shade at either the upper or lower limit, simply press the **STOP/FAVORITE** button to bring the shade to the "favorite" position. To go to the "favorite" position from any other location, make sure the shade has been stopped for at least three seconds before pressing the **STOP/FAVORITE** button.

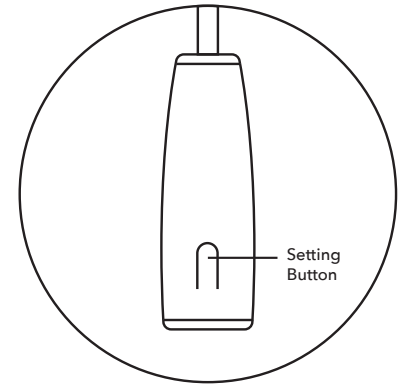

### *Changing a Favorite Position*

Use the **UP** or **DOWN** buttons to position the shade at the new desired "favorite" position. First press and hold the **SETTING** button on the back of the wand. While holding the **SETTING** button, press and hold the **UP** button. Release both buttons when the shade beeps. This establishes a new "favorite" position and erase the old.

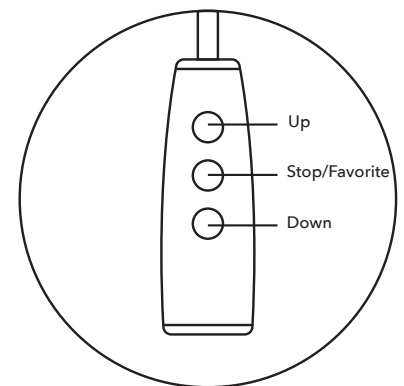

## *Questions and Answers*

**PROBLEM:** Shading will not raise or lower.

**SOLUTION:** Recharge the motor.

**PROBLEM:** Shading continues to move in up or down direction.

**SOLUTION:** Reset the stop positions. See '*Change The Factory Programmed Auto Stop Positions*' section on previous page.

**PROBLEM:** Channel Display screen on Motivia remote does not light up.

**PROBLEM:** The distance required to operate shading with Motivia remote becomes shorter.

**SOLUTION:** Replace the battery in the remote with a CR2430 Lithium battery. Remove the battery tray from the remote by inserting a fingernail into the indentation on the back of the remote. To avoid the battery falling out of the remote, remove the tray while the remote is facing up.

Insert the new battery into the battery tray so that the writing is facing up when the remote is face up. Slide the tray back into the remote.

**PROBLEM:** Nothing I do with my remote seems to work.

**SOLUTION:** REBOOT and RELINK (also known as When in Doubt, Clear it Out). (see next page)

**PROBLEM:** The motor beeps when operated.

**SOLUTION:** The battery power is low. Recharge the motor.

For more trouble shooting help, call us at 800.248.8888 or visit us online at [smithandnoble.com](http://smithandnoble.com) and a live chat assistant is available to help you from 6am - 6pm M-F, 7am-4pm Sat & Sun.

If all else fails, simply REBOOT and RELINK to begin the entire programming process over.

REBOOT and RELINK is also known as, *When in Doubt, Clear it Out*.

- **STEP 1:** Hold the red *Setting\** button down for 10 seconds. The motor will jog during this time and sound like (jog, jog/jog). (Shade shifting up and down) After a single set of jogs, release the red button. If programming more than one shade, then unplug the battery pack of the other shades.
- **STEP 2:** Select the desired channel on the remote.
- **STEP 3:** Hold the red *Setting\** button down again. However, this time hold it **ONLY** long enough so that the shade jogs **ONCE**. Release the button as soon as it jogs.
- **STEP 4:** Flip the remote over to reveal the two buttons, C-Confirm and L-Limit.
- **STEP 5:** Press and hold the *Confirm* button (left side button) until the shade jogs.  
Note: If the shade does not respond, repeat Step 2 above to link shade to remote.
- **STEP 6:** Press and hold the *Limit* button (right side button) until the shade jogs.
- **STEP 7:** Push and release the *Up* or *Down* button to move the shade to the desired upper or lower limits.
- **STEP 8:** When the shade nears your desired upper or lower limits, press the *Stop* button.
- **STEP 9:** Press the *Up* or *Down* buttons to adjust your shade to the precisely desired upper or lower limit. The shade will jog one step each time you press *Up* or *Down*
- **STEP 10:** When the shade has reached the desired location, press and hold the *Confirm* button until the shade jogs. Your limit is now set.
- **STEP 11:** Repeat steps 7 - 10 to set your opposite (either upper or lower) limit.
- **STEP 12:** Run the shade up and down to be sure the limits are set correctly.

**WHAT IS JOGGING?** Jogging refers to the shade shifting up and down.

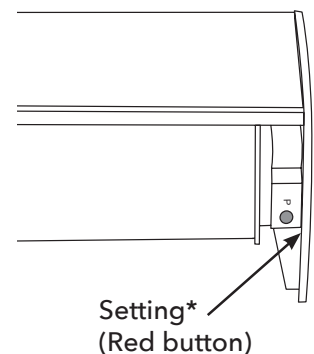

---

\* Setting button is located on the underside of the motor on the shade. (see illustration)