

# SMITH & NOBLE

---

STEP BY STEP INSTALLATION INSTRUCTIONS

## Natural Woven Shades

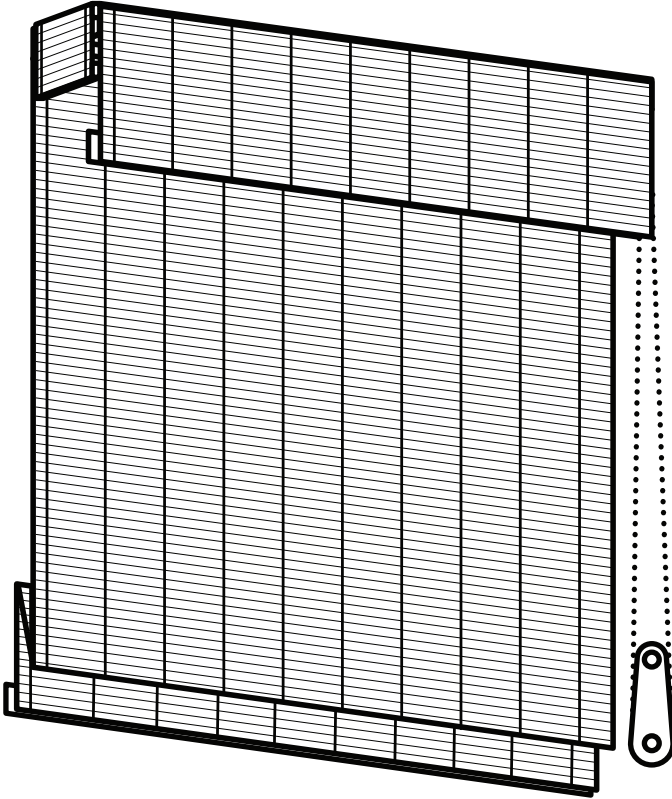

Loop Control

---

---

# Everything You Need

## A Smooth Set-Up

We want you to love your new window coverings and that includes having a smooth installation experience. We recommend saving this guide. If you encounter any difficulties or questions, please reach out to us for help. It's why we're here. Call us at 800.248.8888 for more info on installation.

We recommend you hold on to all packaging until your window coverings are fully installed. Should something go wrong (we strongly doubt it), we want any potential returns to be a painless as possible.

---

### *Customer Service Hours*

Monday – Friday: 6am – 6pm PT

Saturday – Sunday: 7am – 4pm PT

[smithandnoble.com](http://smithandnoble.com)



---

## Table of Contents

<i>Step 1</i> - Getting Started . . . . .	3
<i>Overview</i> - Loop Control & Bracket Quantity . . . . .	4
<i>Step 2</i> - Mounting the Brackets . . . . .	5 - 6
<i>Step 2</i> - Attaching Shade to Bracket . . . . .	6
<i>Step 3</i> - Attaching the Loop Control Tensioner . . . . .	7
<i>Step 4</i> - Installing the Cord Tensioner . . . . .	8
<i>Step 4</i> - Operating the Shade . . . . .	8
(Optional) Hold Down Brackets . . . . .	9
Troubleshooting . . . . .	10
Care & Cleaning . . . . .	10
Safety . . . . .	10
Warranty . . . . .	Back Cover

## Getting Started



First, make sure you have all the parts and tools required to install your shades.

### ALL THE HARDWARE YOU'LL NEED:

Pencil, screw-driver, 1/4" nut driver, level, and a drill with a 1/8" drill bit.

Then find wooden studs where you'll want to attach the brackets; if you need to mount your shades to wallboard or plaster, use a secure fastener designed for hollow wall applications. For metal surfaces, pre-drill holes and use the included screws. For concrete, stone, brick, or tile surfaces, use a masonry drill and appropriate plugs, anchors, or screws.

It's important when selecting a fastener to make sure it's designed to support the weight of the shade. Follow the fastener manufacturer's instruction from there on out.

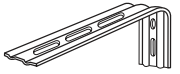
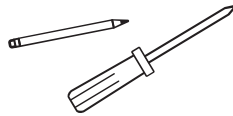
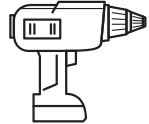
 SCREWS	 MOUNTING BRACKETS
 LEVEL (NOT INCLUDED)	 EXTENSION BRACKET (OPTIONAL)
 PENCIL & SCREWDRIVER (NOT INCLUDED)	 POWER DRILL (NOT INCLUDED)

## Loop Control

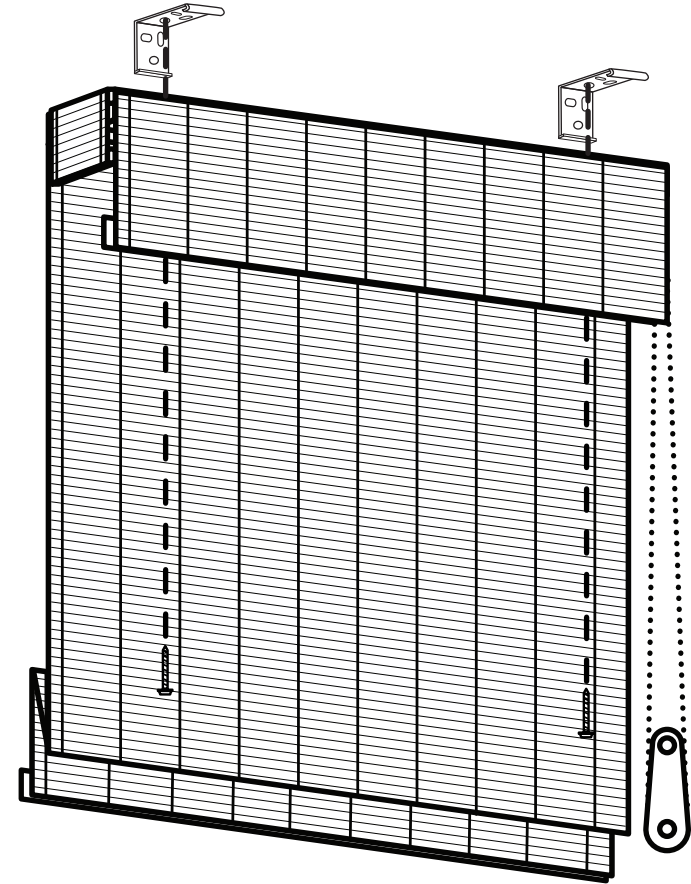

## Step 2 – Mounting Brackets

### Inside Mount

Cord Loop shades come with snap-in bracket connectors which are pre-attached to the top of the shade's headrail. These pre-attached bracket connectors are pre-aligned for their proper mounting position and will snap into the installation brackets once installed.

Position and install brackets inside the frame using the top holes. (Make sure they are aligned with pre-attached bracket connectors.) Release tab should be positioned at the bottom.

Next, follow steps for attaching shade to the bracket.

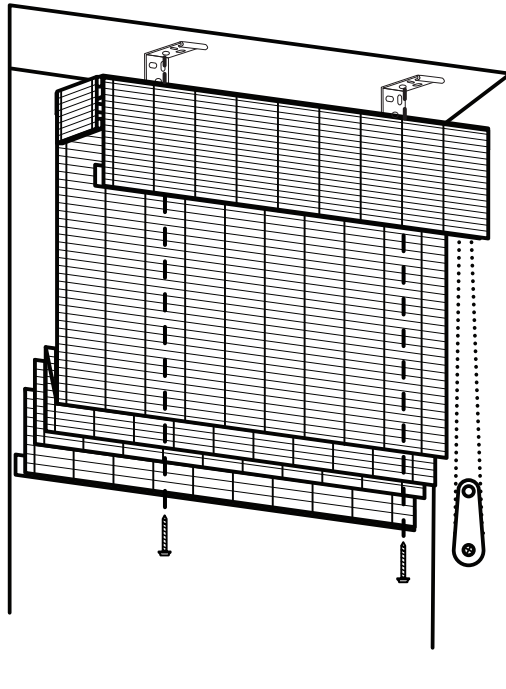

BRACKET QTY	SHADE WIDTH
2	up to 36"
3	36 1/8"–72"
4	72 1/8"–96"
5	96 1/8" and up

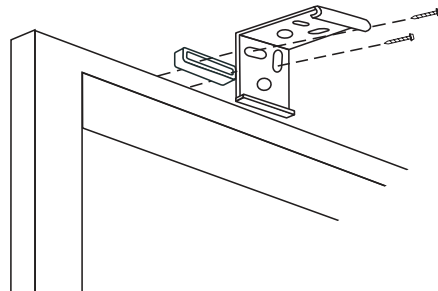

## Step 2 – Mounting Brackets

### Outside Mount

Center the shade over the window opening at the desired height. Mark the position of the ends of the headrail on the wall with a pencil.

Position brackets so they are aligned with pre-attached bracket connector. Install brackets using the back holes. Make sure the release tab is positioned at the bottom.

Next, follow steps for attaching shade to the bracket.

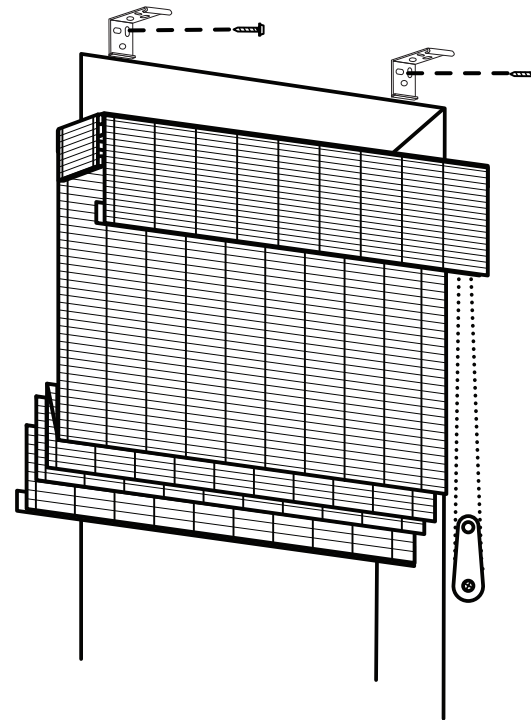

### Attaching Shade to Bracket

Figure (A) - Position the shade with front hook of the pre-attached, headrail bracket connector resting on the top lip of all mounted brackets.

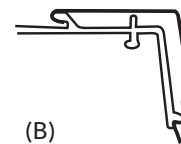
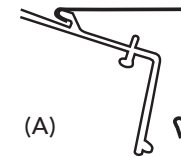
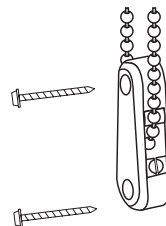
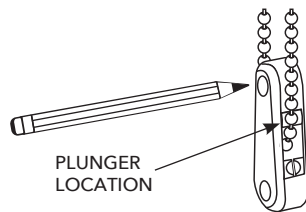
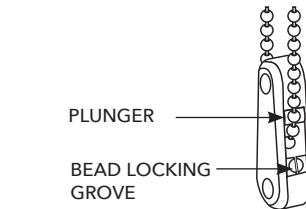

Figure (B) - Push the bottom front of the shade headrail firmly backwards and toward the window until the lip on the rear of the pre-attached headrail bracket connector engages the mounting bracket and snaps into place, as shown.

## Step 3 – Loop Control Cord Tensioner

### Installing the Loop Control Tensioner

Your window shade has arrived with a cord tensioner to comply with current child safety standards. The cord tensioner must be mounted and secured before the window shade will operate correctly. Before doing anything, you must first slide the tension device to the bottom of the bead chain. While holding the tension device in one hand, pull the plunger away from the bead chain with the other hand. Lift the bead chain out of the bead locking groove and slide the tension device to the bottom of the chain loop. Pull the tension device down until the bead chain is fully tensioned (plunger will be at the top) and then move the tension device up approximately 1/8". Mark the screw hole locations on the wall with a pencil.



#### INSIDE MOUNT

If mounting into wood, pre drill screw holes and then install the tension device using the 2 large screws provided.

If not securing into wood, use appropriate anchors for the substrate and follow anchor manufacturer's instructions.

#### OUTSIDE MOUNT

Align the mounting bracket sight holes with the pencil marks.

If mounting into wood, pre-drill screw holes and then install the mounting bracket using the 2 large screws provided.

If not securing into wood, use appropriate anchors for the substrate and follow anchor manufacturer's instructions.

Press the tension device onto the mounting bracket posts. Carefully install the 2 small screws provided, through the tension device into the mounting bracket using a phillips head screwdriver.

**DO NOT OVER-TIGHTEN.**

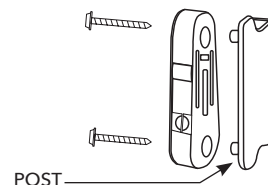
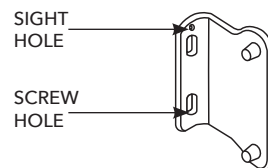

## Step 4 – Operating the Shade

### Operating the Tensioner

Opening and closing your new shades is entirely hassle-free. Using the loop control, pull the rear bead chain to lower the shade and, pull the front bead chain to raise.

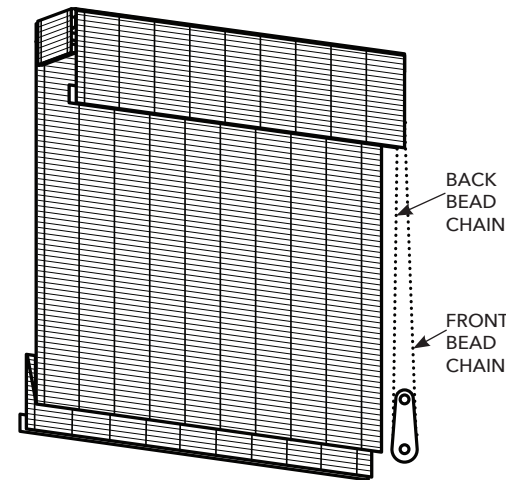

### Hold Down Bracket (optional)

Hold-down brackets are used to secure the bottom hem of the shade in situations where excessive movement may be a problem. To install, pre-drill the pin holes in each end of the hem dowel using a  $\frac{7}{64}$ " drill bit. The depth of the holes should be half the length of the pin. Lower the shade completely and mark the position where the hold down bracket will be mounted. Attach the hold down bracket with the screws provided.

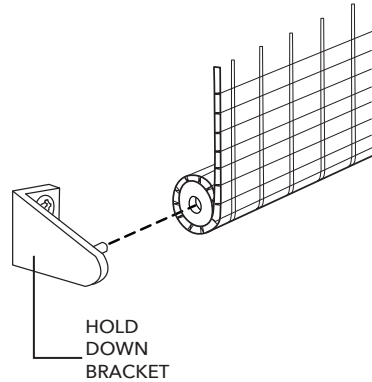

PROBLEM	SOLUTION
The shade will not raise or lower.	Make sure tension device has been installed properly.
Only one side of the shade moves when the loop cord is pulled.	The shade may be caught on an obstruction such as a window crank or latch; if this is the case, feel free to untangle it. If one of the lift cords has come untied, simply re-tie the cord.
The shade is not raising evenly.	Check that the cords are not tangled as they wrap around the rod shaft at the headrail.

*If these suggestions do not work, then please give us a call at 800.248.8888 or visit [www.smithandnoble.com](http://www.smithandnoble.com).*

## Care & Cleaning/Safety

### Care & Cleaning

Use brush or dust head attachment. Occasional light vacuuming with a soft bristle attachment or gentle feather dusting is all that is required to keep your shades looking fresh and neat.

### Safety First. Style Second To None™

Great style should never come at the cost of safety. Every Smith & Noble window treatment conforms strictly to today's safety standards, including permanent tie-down devices and built-in cord stops. To protect young children and pets, Loop Control works with a cord tensioner, which must be mounted to your window frame or wall. The shade or blind will not work if the cord tensioner is not mounted. Call us at 800.248.8888 or visit [smithandnoble.com/childsafety](http://smithandnoble.com/childsafety).

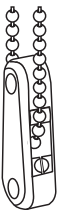

**Child Safety**

---

## Warranty Service

The enjoyment of your window coverings should be everlasting, which is why our products come with a limited lifetime warranty. The warranty applies to the original owner, requires a proof of purchase and covers defects in material or craftsmanship. Shades or blinds must have been properly installed. We reserve the right to determine if your window covering warrants a repair or a replacement. In need of warranty service? Call us at **800.248.8888** and we'll arrange for a repair or replacement ASAP.

---