

# SMITH & NOBLE

---

Step by Step Installation Instructions

## *Sundry Hardware*

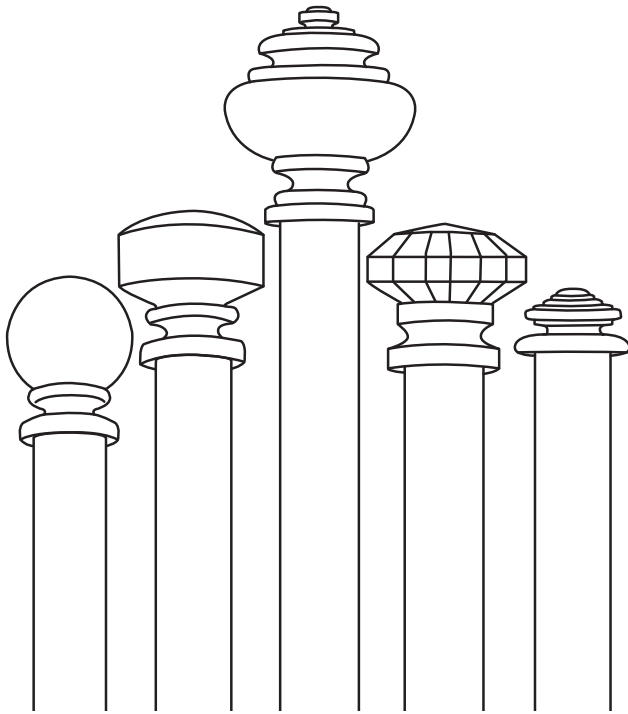

Ceiling Mount  
Single Corner Rod Set

---

---

# Everything You Need

## A Smooth Set-Up

We want you to love your new hardware and that includes having a smooth installation experience. If you encounter any difficulties or questions, please reach out to us for help. It's why we're here. Call us at 800.248.8888 or visit [www.smithandnoble.com/knowhow](http://www.smithandnoble.com/knowhow) for more info on installation.

We recommend you hold on to all packaging until your hardware is fully installed. Should something go wrong (we strongly doubt it), we want any potential returns to be a painless as possible.

---

### **Customer Service Hours**

Monday – Friday: 6am – 7pm PT

Saturday – Sunday: 7am – 4pm PT

[smithandnoble.com](http://smithandnoble.com)



---

## Table of Contents

|                   |  |            |
|-------------------|--|------------|
| <i>Step 1 -</i>   | Getting Started .....                    | 3          |
| <i>Overview -</i> | Ceiling Mount Single Corner Rod Set..... | 4          |
| <i>Step 2 -</i>   | Mounting the Brackets .....              | 5          |
| <i>Step 3 -</i>   | Rod Connectors .....                     | 6          |
| <i>Step 4 -</i>   | Attaching the Finials .....              | 6-7        |
| <i>Step 5 -</i>   | Securing Rod to Brackets .....           | 8          |
|                   | Accessories .....                        | 8-9        |
|                   | Care & Cleaning .....                    | 10         |
|                   | Warranty .....                           | Back Cover |

## Parts and Tools

Before you begin, check the accompanying diagram to make sure you have all the parts you need. You'll need to make sure the surface you intend to install your hardware is sturdy enough to accommodate the brackets. If you're screwing directly into a surface this means locating wood studs that are strong enough to securely bond with the included screws. Otherwise, you'll need to use a secure fastener (as illustrated) but please note this piece is not included.







**WALLBOARD OR PLASTER:** Hollow wall applications: Use a secure fastener designed specifically for this purpose.

**METAL:** Prepare by pre-drilling holes and then using the included screws.

**CONCRETE, STONE, BRICK OR TILE:** Use a masonry drill and surface-specific plugs, anchors, or screws. When selecting a fastener be sure it's designed to support the weight of the product being installed (if you're not sure, either give us a call or ask a professional at your local hardware store). Once obtained, follow the fastener manufacturer's instructions regarding proper installation.

**TOOLS YOU WILL NEED TO INSTALL YOUR HARDWARE:** Pencil, screwdriver, 1/4" nut driver, level, and a drill with a 3/64" drill bit.

*Note: It's important to monitor the amount of pressure you apply when using a drill. If the screws are too tight this may cause the screw itself to break off in the wall or window frame.*

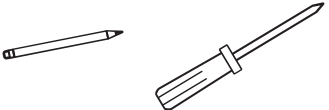
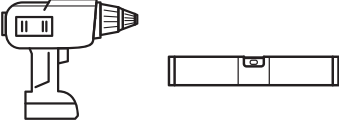
|  |   |
|--|---|
| <br>CEILING MOUNTING BRACKET             | <br>HINGED ELBOW                        |
| <br>SCREWS                              | <br>RINGS                              |
| <br>PENCIL & SCREWDRIVER (NOT INCLUDED) | <br>POWER DRILL & LEVEL (NOT INCLUDED) |

## Ceiling Mount Single Corner Rod Set

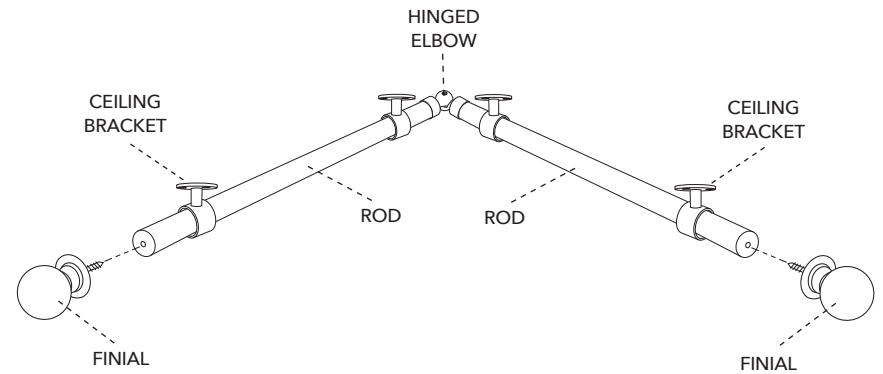

| ROD QTY | BRACKET QTY | ELBOW QTY | ROD WIDTH     |
|---------|-------------|-----------|---------------|
| 2       | 4           | 1         | 12"-48"       |
| 2       | 6           | 1         | 48 1/4"-72"   |
| 2       | 6           | 1         | 72 1/4"-96"   |
| 4       | 6           | 1         | 96 1/4"-120"  |
| 4       | 6           | 1         | 120 1/4"-144" |
| 4       | 8           | 1         | 144 1/4"-168" |
| 4       | 8           | 1         | 168 1/4"-192" |
| 6       | 10          | 1         | 192 1/4"-216" |
| 6       | 10          | 1         | 216 1/4"-240" |
| 6       | 12          | 1         | 240 1/4"-264" |
| 6       | 12          | 1         | 264 1/4"-288" |
| 8       | 14          | 1         | 288 1/4"-312" |
| 8       | 14          | 1         | 312 1/4"-336" |
| 8       | 16          | 1         | 336 1/4"-360" |
| 8       | 16          | 1         | 360 1/4"-384" |

## Step 2 – Mounting the Brackets

### Mounting the Brackets

#### STEP 1:

Center the rod over the window opening or the ceiling. Using the pencil, mark where the ends of the rod is positioned; if you're using a center bracket, note the middle point between these two spots as well. If you have more than one center bracket spread these evenly between the two end brackets and center point. Measure 2" inward from the marks you've made on both ends and mark those spots. This is where the brackets will be installed.

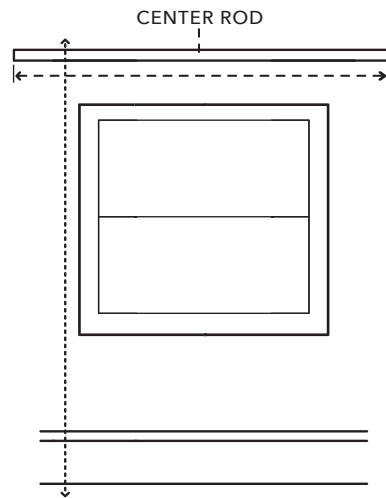

#### STEP 2:

Place the bracket directly at the marked spots and then mark the location of the three screw holes with your pencil. Once you've established where everything should go, put the bracket aside and double-check to make sure the pencil marks are level with each other. Next, pre-drill the holes in their assigned spot, making sure it's the right depth for the supplied screws. Install your brackets.

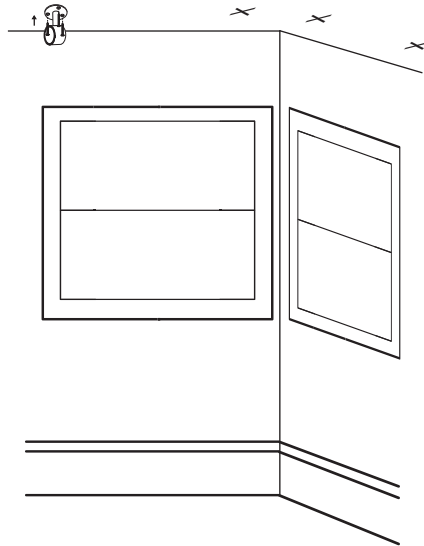

## Step 3 - Attaching Rod Connector

### Rod Connector

Depending on your order, you may have received a rod connector. A rod connector is a two sided screw that connects the rods together.

#### STEP 1:

Screw the two sided screw connector to one end of the rod.

#### STEP 2:

Screw in the second rod to the other side of the two sided screw until both rods are tightly together and there is no visible gap.

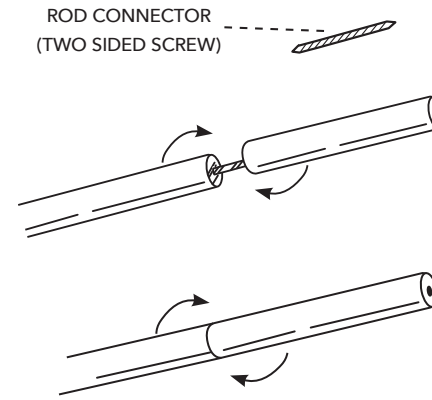

## Step 4 - Attaching the Finials

### Attaching Finials

#### STEP 1:

For treatments using rings and do not have a center support bracket, insert the rod through the first bracket and then place the required number of rings on the rod but leave two rings out. **If opening from the middle (Split Draw) or one if opening drapery from one side.** Then slide the rod through the second bracket. All the rings should now be in between the two brackets. For split drapery, add a ring at one end of the rod and then attach the finial. This will prevent drapery to be pulled all the way to one side or the other when opening and closing it. If you are opening your drapery only from one side, leave one ring between the finial and bracket on the side you won't be opening it from. Finials will come with a threaded base. Simply screw the finial into the end of the rod. Repeat on the other sides.

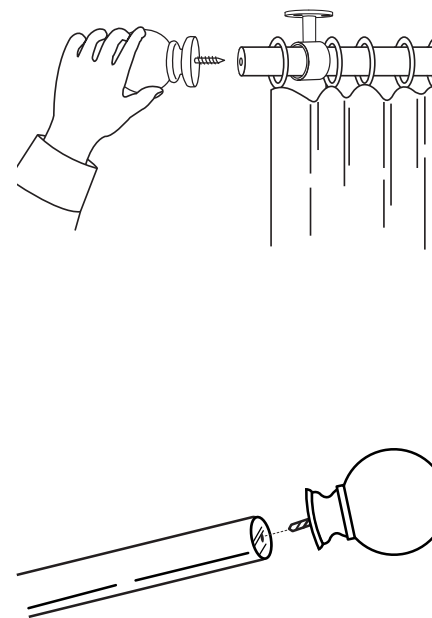

## Step 4 - Attaching the Finials

### Attaching Finials

#### STEP 2:

Attach the elbow and proceed to connect the rod to the other end of the elbow, add remaining rings and finish by attaching the second finial.

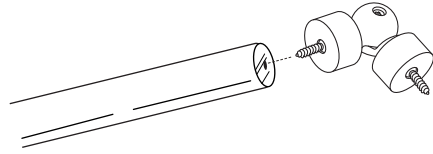

#### NOTE:

For treatments without rings and no center support bracket, attach the finial to one end of the rod, and slide it through the first bracket. Position the drapery panel on the rod, and then slide it through the second bracket. Attach the elbow and proceed to connect the rod to the other end of the elbow. Position the drapery panel on the rod, and then slide it through the bracket. Attach the elbow and proceed to connect the rod to the other end of the elbow. Position the drapery panel on the rod, and then slide it through the bracket. Finish by attaching the second finial.

For treatments without rings and a center support bracket, attach the finial to one end of the rod, and slide it through the first bracket. Position one of the drapery panels on the rod, and then slide the rod through the center support bracket. Position the other drapery panel on the rod, and then slide the rod through the last next bracket. Attach the elbow and proceed to connect the rod to the other end of the elbow. Position the drapery panel on the rod, and then slide the rod through the center support bracket. Position the other drapery panel on the rod, and then slide the rod through the last next bracket. Attach the elbow and proceed to connect the rod to the other end of the elbow. Position the drapery panel on the rod, and then slide the rod through the center support bracket. Position the other drapery panel on the rod, and then slide the rod through the last next bracket. Finish by attaching the second finial.

## Step 5 - Securing Rod to Brackets

### Securing Rod to Brackets

#### STEP 1:

Once the rod has been placed on the brackets, secure the rod in place by tightening the bracket set screw.

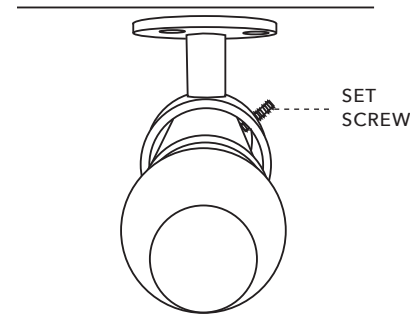

## Accessories

### Baton/Wand (optional)

After your hardware is installed, attach the baton to the eyelet of the first ring by the clip.

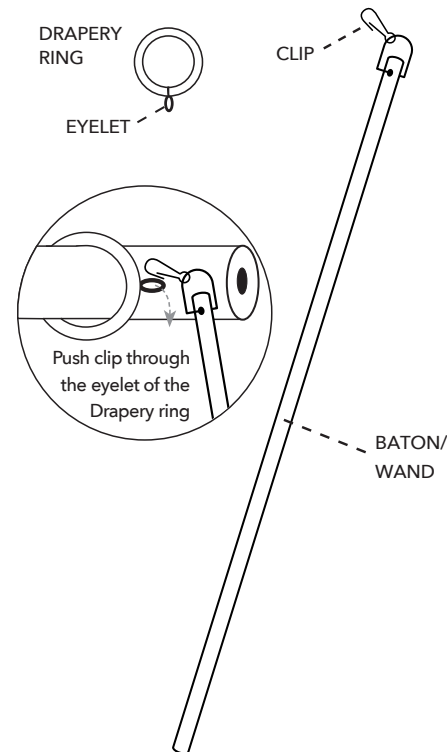

Tiebacks (Optional)

**STEP 1**

In order to locate where to install your tiebacks, measure the height of the window and divide this by two.

Using the previous calculation, mark that spot on the wall with a pencil. To ensure you like the way the panel drapes, gather one side and sweep it over to the approximate proposed location.

Once you're sure the tieback is in the perfect location, use your pencil to mark the spot to install it.

Measure the distance from the bottom or top of the window to the tieback to mark the other side and ensure they're even.

Now hold the tieback hardware on the wall at the desired location and rest a level above it, adjusting it until it's straight.

**STEP 2**

Place tieback level against wall in desired locations and lightly draw a circle around the base of the tieback onto wall, see **Figure A**.

Remove tieback post and cover from mounting plate.

Center mounting plate inside of the circle outline on wall.

Attach the metal mounting plate to the wall. Be sure and attach the plate to the wall with the appropriate mounting hardware.

Place cover over the mounting plate.

Thread tieback post onto the mounting plate, see **Figure B**.

Figure A

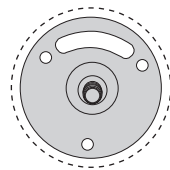
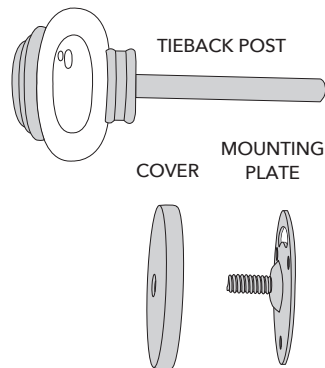
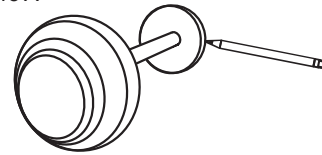
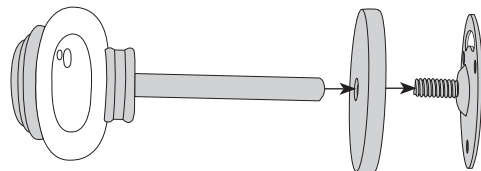

Figure B



Care & Cleaning

Minimal care and cleaning is needed to maintain the beauty of your Hardware.

To Vacuum: Use brush or dust head attachment.

To Dust: Use soft, clean cloth.

---

## Warranty Service

The enjoyment of your hardware should be everlasting, which is why our products come with a limited lifetime warranty. The warranty applies to the original owner, requires a proof of purchase (hang on to your receipt!) and covers defects in material or craftsmanship. Hardware must have been properly installed. We reserve the right to determine if your hardware warrants a repair or a replacement. **Visit [smithandnoble.com/guarantee](https://smithandnoble.com/guarantee)** to see full details. In need of warranty service? Call us at **800.248.8888** and we'll arrange for a repair or replacement ASAP.

---