

# SMITH & NOBLE

---

Step by Step Installation Instructions

## *Sundry Hardware*

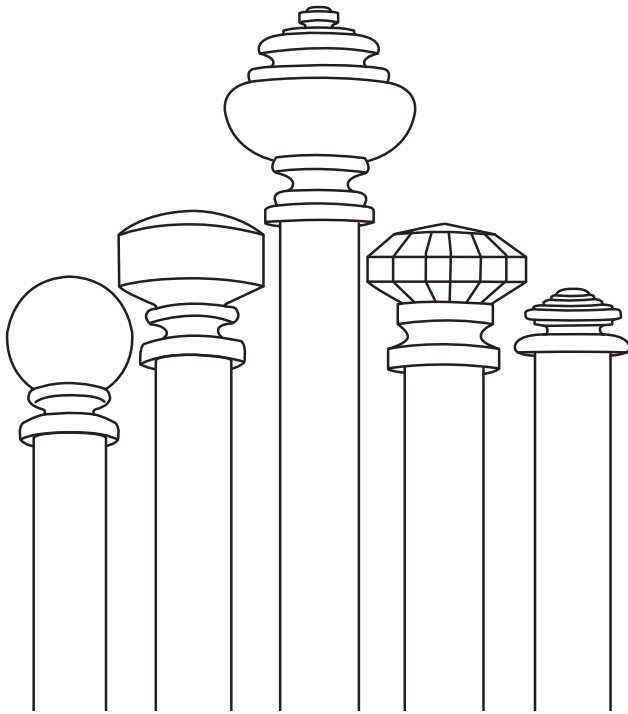

Wall Mount  
Single Corner Rod Set

---

---

# Everything You Need

## A Smooth Set-Up

We want you to love your new hardware and that includes having a smooth installation experience. If you encounter any difficulties or questions, please reach out to us for help. It's why we're here. Call us at **800.248.8888** or visit [www.smithandnoble.com/knowhow](http://www.smithandnoble.com/knowhow) for more info on installation.

We recommend you hold on to all packaging until your hardware is fully installed. Should something go wrong (we strongly doubt it), we want any potential returns to be a painless as possible.

---

### **Customer Service Hours**

Monday – Friday: 6am – 7pm PT

Saturday – Sunday: 7am – 4pm PT

[smithandnoble.com](http://smithandnoble.com)



---

## Table of Contents

<i>Step 1 -</i>	Getting Started .....	3
<i>Overview -</i>	Wall Mount Single Corner Rod Set .....	4
<i>Step 2 -</i>	Mounting the Brackets .....	5
<i>Step 3 -</i>	Rod Connectors .....	6
<i>Step 4 -</i>	Attaching the Finials & Hinged Elbow .....	7
<i>Step 5 -</i>	Securing Rod to Brackets .....	7
	Accessories (optional).....	8-9
	Care & Cleaning .....	9
	Notes .....	10
	Warranty.....	Back Cover

## Parts and Tools

Before you begin, check the accompanying diagram to make sure you have all the parts you need. You'll need to make sure the surface you intend to install your hardware is sturdy enough to accommodate the brackets. If you're screwing directly into a surface this means locating wood studs that are strong enough to securely bond with the included screws. Otherwise, you'll need to use a secure fastener (as illustrated) but please note this piece is not included.



**WALLBOARD OR PLASTER:** Hollow wall applications: Use a secure fastener designed specifically for this purpose.

**METAL:** Prepare by pre-drilling holes and then using the included screws.

**CONCRETE, STONE, BRICK OR TILE:** Use a masonry drill and surface-specific plugs, anchors, or screws. When selecting a fastener be sure it's designed to support the weight of the product being installed (if you're not sure, either give us a call or ask a professional at your local hardware store). Once obtained, follow the fastener manufacturer's instructions regarding proper installation.

**TOOLS YOU WILL NEED TO INSTALL YOUR HARDWARE:** Pencil, screwdriver, 1/4" nut driver, level, and a drill with a 7/64" drill bit.

*Note: It's important to monitor the amount of pressure you apply when using a drill. If the screws are too tight this may cause the screw itself to break off in the wall or window frame.*

<p>SCREWS</p>	<p>3" STANDARD END &amp; CENTER BRACKET      6" EXTENSION END &amp; CENTER SUPPORT BRACKET</p>
<p>CENTER BYPASS SUPPORT BRACKET (OPTIONAL FOR C-RINGS)</p>	<p>HINGED ELBOW / RINGS &amp; C-RINGS (OPTIONAL)</p>
<p>PENCIL &amp; SCREWDRIVER (NOT INCLUDED)</p>	<p>POWER DRILL &amp; LEVEL (NOT INCLUDED)</p>

## Corner Wall Mount Single Rod Set

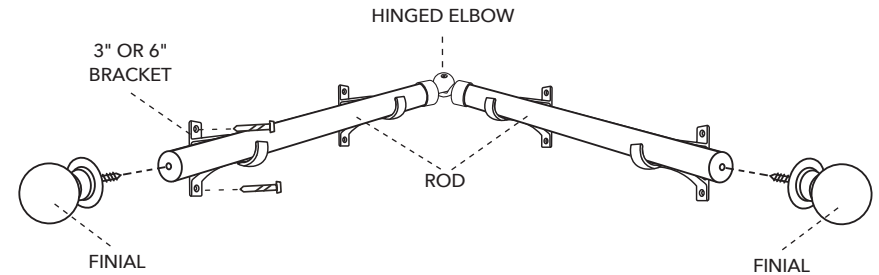

ROD QTY	BRACKET QTY	SINGLE - ELBOWS QTY	ROD WIDTH
2	4	1	12" – 48"
2	6	1	48 1/4" – 96"
4	6	1	96 1/4" – 144"
4	8	1	144 1/4" – 192"
6	10	1	192 1/4" – 240"
6	12	1	240 1/4" – 288"
8	14	1	288 1/4" – 336"
8	16	1	336 1/4" – 384"

## Step 2 - Mounting the Brackets

### Mounting the Brackets

#### STEP 1:

Place the panel on the rod. To ensure it drapes at the correct length, hold it up to the spot you wish to install it. Raise or lower your treatment as desired. After you've located the ideal location, use a pencil to mark where the top of the rod is resting.

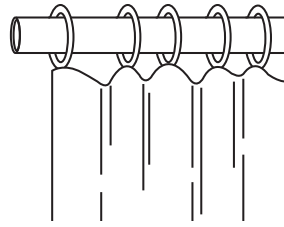

#### STEP 2:

Remove the panel from the rod and then center the rod over the window opening at the desired height. Using the pencil, mark where the ends of each rod are positioned; if you're using a center bracket, note the middle point between these two spots as well. If you have more than one center bracket spread these evenly between the two end brackets and center point. Measure 2" inward from the marks you've made on both ends and mark those spots. This is where the brackets will be installed.

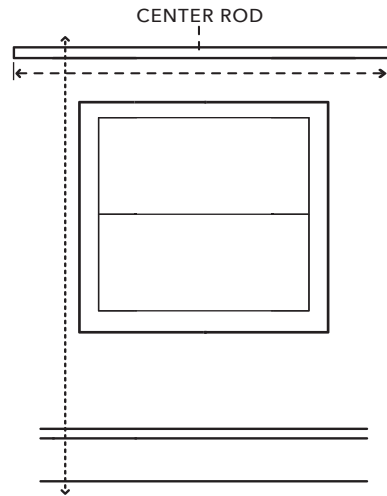

#### STEP 3:

Place the brackets so that the horizontal plate bracket is aligned with the marked height and then mark the location of the screw holes with your pencil. Once you've established where everything should go, put the bracket aside and double-check to make sure the pencil marks are level with each other. Next, pre-drill the holes in their assigned spot, making sure it's the right depth for the supplied screws. Install your brackets.

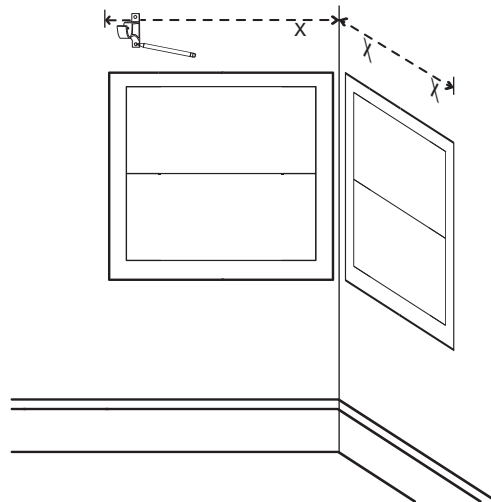

## Step 3 – Attaching Rod Connector

### Rod Connector

Depending on your order, you may have received a rod connector. A rod connector is a two sided screw that connects the rods together.

#### STEP 1:

Screw the two sided screw connector to one end of the rod.

#### STEP 2:

Screw in the second rod to the other side of the two sided screw until both rods are tightly together and there is no visible gap.

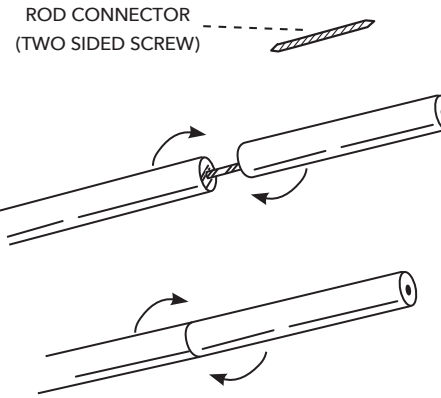

### Attaching Finials & Hinged Elbow

#### STEP 1:

For treatments using rings, attach the finial to one end of the rod, place the required number of rings on the rod. Finials will come with a threaded base. Simply screw the finial into the threaded end of the rod. For split drapery, when placing the rod on the bracket, leave one ring between the finial and bracket on each side. This will prevent drapery to be pulled all the way to one side or the other when opening and closing it. If you are opening your drapery only from one side, leave one ring between the finial and bracket on the side you won't be opening it from.

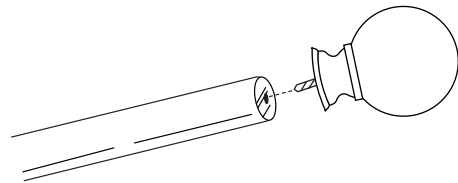
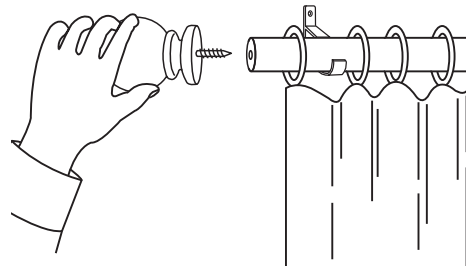

#### STEP 2:

Attach the elbow and proceed to connect the rod to the other end of the elbow, add remaining rings and finish by attaching the second finial.

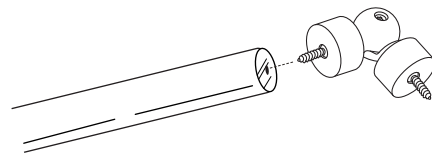

**NOTE:** For treatments without rings, attach the finial to one end of the rod, position the drapery panels on rod, attach an elbow and continue to attach another rod to the second end of the elbow. Position remaining drapery panels and finish by attaching the second finial.

## Step 5 - Securing Rod to Brackets

### Securing Rod to Brackets

#### STEP 1:

Once the rod had been placed on the brackets, secure the rod in place by tightening the bracket set screw.

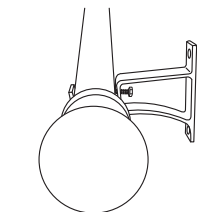

#### STEP 2:

If your rod set comes with bypass center support brackets secure the rod by screwing in the enclosed small screw into the bottom of the bracket and rod.

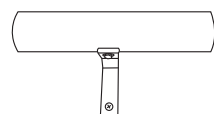

Figure A

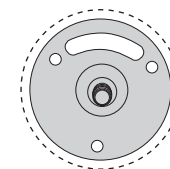
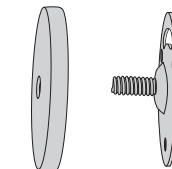
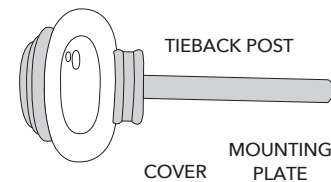
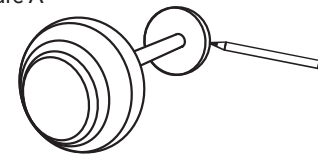
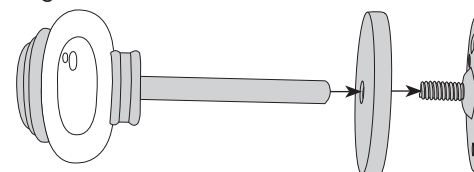

Figure B



### Tiebacks (Optional)

#### STEP 1

In order to locate where to install your tiebacks, measure the height of the window and divide this by two.

Using the previous calculation, mark that spot on the wall with a pencil. To ensure you like the way the panel drapes, gather one side and sweep it over to the approximate proposed location.

Once you're sure the tieback is in the perfect location, use your pencil to mark the spot to install it.

Measure the distance from the bottom or top of the window to the tieback to mark the other side and ensure they're even.

Now hold the tieback hardware on the wall at the desired location and rest a level above it, adjusting it until it's straight.

#### STEP 2

Place tieback level against wall in desired locations and lightly draw a circle around the base of the tieback onto wall, see Figure A.

Remove tieback post and cover from mounting plate.

Center mounting plate inside of the circle outline on wall.

Attach the metal mounting plate to the wall, using the appropriate mounting hardware.

Place cover over the mounting plate.

Thread tieback post onto the mounting plate, see Figure B.

**Baton/Wand (optional)**

After your hardware is installed, attach the baton to the eyelet of the first ring by the clip.

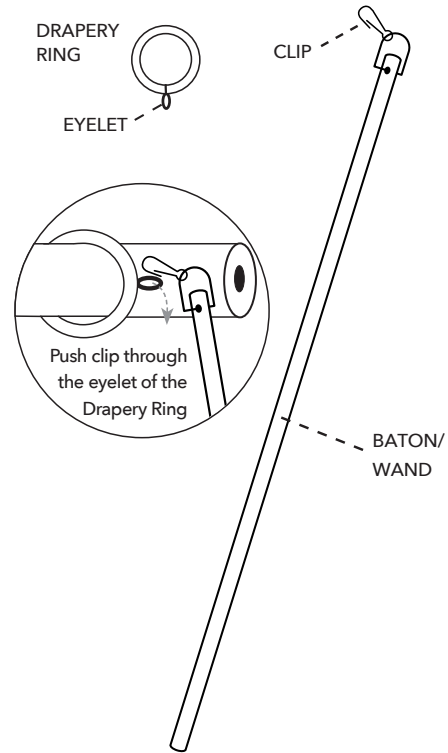

***Care & Cleaning***

---

**Care & Cleaning**

Minimal care and cleaning is needed to maintain the beauty of your Hardware.

To Vacuum: Use brush or dust head attachment.

To Dust: Use soft, clean cloth.

---

## Warranty Service

The enjoyment of your hardware should be everlasting, which is why our products come with a limited lifetime warranty. The warranty applies to the original owner, requires a proof of purchase (hang on to your receipt!) and covers defects in material or craftsmanship. Hardware must have been properly installed. We reserve the right to determine if your hardware warrants a repair or a replacement. Visit [smithandnoble.com/guarantee](https://smithandnoble.com/guarantee) to see full details. In need of warranty service? Call us at **800.248.8888** and we'll arrange for a repair or replacement ASAP.