

# SMITH & NOBLE

---

Step by Step Installation Instructions

## *Sundry Hardware*

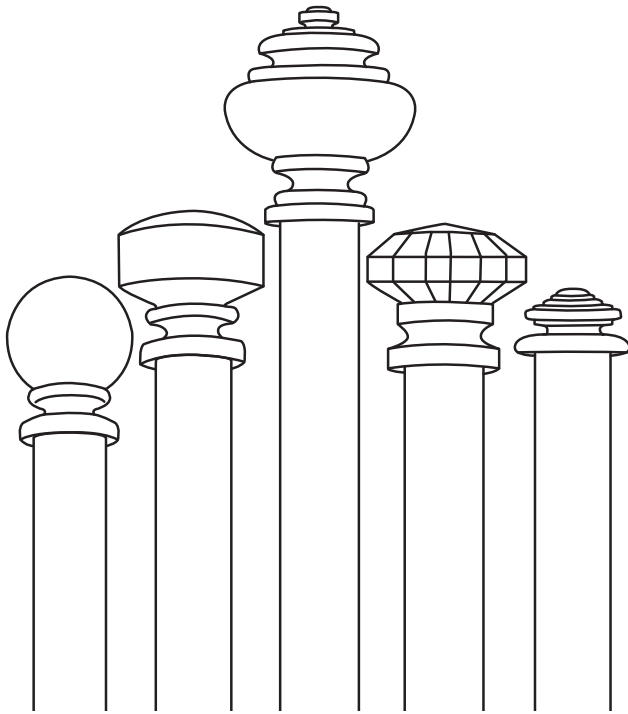

Inside Mount  
Single Rod Set

---

---

# Everything You Need

## A Smooth Set-Up

We want you to love your new hardware and that includes having a smooth installation experience. If you encounter any difficulties or questions, please reach out to us for help. It's why we're here. Call us at **800.248.8888** or visit **[www.smithandnoble.com/knowhow](http://www.smithandnoble.com/knowhow)** for more info on installation.

We recommend you hold on to all packaging until your hardware is fully installed. Should something go wrong (we strongly doubt it), we want any potential returns to be a painless as possible.

---

### *Customer Service Hours*

Monday – Friday: 6am – 7pm PT

Saturday – Sunday: 7am – 4pm PT

[smithandnoble.com](http://smithandnoble.com)



---

## Table of Contents

<i>Step 1</i> -	Getting Started .....	3
<i>Overview</i> -	Inside Mount Single Rod Set .....	4
<i>Step 2</i> -	Mounting the Brackets .....	5
<i>Step 3</i> -	Securing Rod to Brackets .....	6
Accessories .	.....	7 - 8
Care & Cleaning	.....	9
Notes .....	.....	10
Warranty .....	.....	Back Cover

## Parts and Tools

Before you begin, check the accompanying diagram to make sure you have all the parts you need. You'll need to make sure the surface you intend to install your hardware is sturdy enough to accommodate the brackets. If you're screwing directly into a surface this means locating wood studs that are strong enough to securely bond with the included screws. Otherwise, you'll need to use a secure fastener (as illustrated) but please note this piece is not included.





**WALLBOARD OR PLASTER:** Hollow wall applications: Use a secure fastener designed specifically for this purpose.

**METAL:** Prepare by pre-drilling holes and then using the included screws.

**CONCRETE, STONE, BRICK OR TILE:** Use a masonry drill and surface-specific plugs, anchors, or screws. When selecting a fastener be sure it's designed to support the weight of the product being installed (if you're not sure, either give us a call or ask a professional at your local hardware store). Once obtained, follow the fastener manufacturer's instructions regarding proper installation.

**TOOLS YOU WILL NEED TO INSTALL YOUR HARDWARE:** Pencil, screwdriver, 1/4" nut driver, level, and a drill with a 7/64" drill bit.

*Note: It's important to monitor the amount of pressure you apply when using a drill. If the screws are too tight this may cause the screw itself to break off in the wall or window frame.*

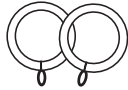
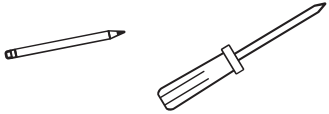
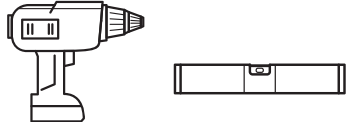
 <p>SCREWS</p>	 <p>INSIDE MOUNTING BRACKETS</p>
 <p>C - RINGS (OPTIONAL)</p>	 <p>RINGS (OPTIONAL)</p>
 <p>PENCIL &amp; SCREWDRIVER (NOT INCLUDED)</p>	 <p>POWER DRILL &amp; LEVEL (NOT INCLUDED)</p>

## Inside Mount Single Rod Set



ROD QTY	BRACKET QTY	ROD WIDTH
1	2	12"– 48"

## Step 2 – Mounting the Brackets

### Inside Mount

#### STEP 1:

Place the panel on the rod. To ensure it drapes at the correct length, hold it up to the spot you wish to install it. Raise or lower your treatment as desired. After you've located the ideal location, use a pencil to mark where the top of the rod is resting.



#### STEP 2:

Using a pencil, mark the position on both sides of the window frame where the brackets will be attached.

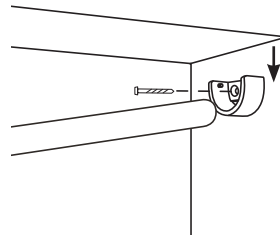

#### STEP 3:

Make sure the brackets are aligned and level with one another.

#### STEP 4:

Position the inside mounting bracket with the openface end facing upward, and the set screw in the back. Attach it with the screws provided.

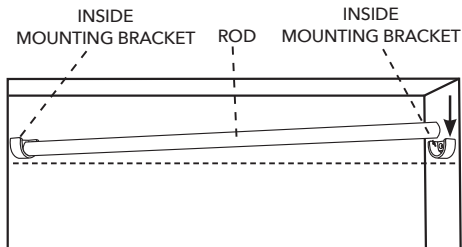

#### STEP 5:

Once both brackets are installed and level, simply place the drapery on the rod and place the hardware rod into the inside mounting bracket. Tighten set screw to hold rod in place.

#### NOTE:

If your treatment requires rings they need to be placed onto the rod before installing it into the brackets.

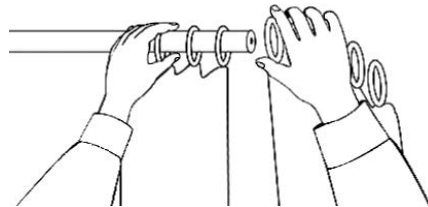

## Step 3 - Securing Rod to Brackets

### Securing Rod to Brackets

#### STEP 1:

Once the rod had been placed on the brackets, secure the rod in place by tightening the bracket set screw.

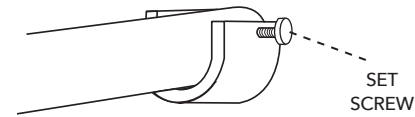

**Baton/Wand (optional)**

After your hardware is installed, attach the baton to the eyelet of the first ring by the clip.

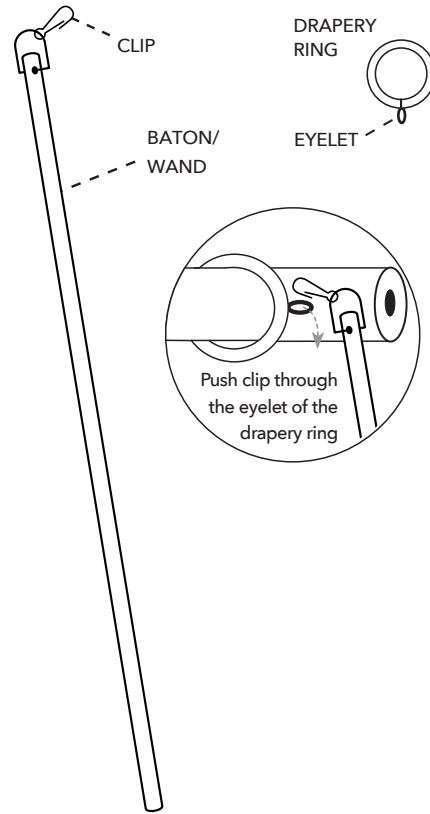

**Tiebacks (Optional)**

**STEP 1**

In order to locate where to install your tiebacks, measure the height of the window and divide this by two.

Using the previous calculation, mark that spot on the wall with a pencil. To ensure you like the way the panel drapes, gather one side and sweep it over to the approximate proposed location.

Once you're sure the tieback is in the perfect location, use your pencil to mark the spot to install it.

Measure the distance from the bottom or top of the window to the tieback to mark the other side and ensure they're even.

Now hold the tieback hardware on the wall at the desired location and rest a level above it, adjusting it until it's straight.

**STEP 2**

Place tieback level against wall in desired locations and lightly draw a circle around the base of the tieback onto wall, see **Figure A**.

Remove tieback post and cover from mounting plate.

Center mounting plate inside of the circle outline on wall.

Attach the metal mounting plate to the wall using the appropriate mounting hardware.

Place cover over the mounting plate.

Thread tieback post onto the mounting plate, see **Figure B**.

Figure A

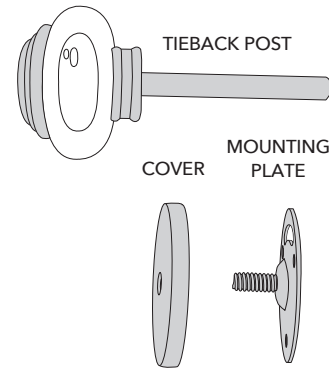
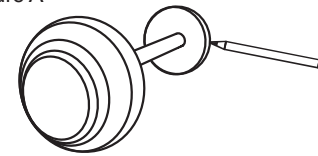
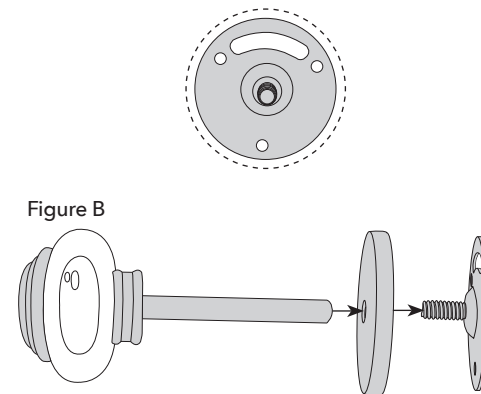

Figure B



**Care & Cleaning**

Minimal care and cleaning is needed to maintain the beauty of your Hardware.

To Vacuum: Use brush or dust head attachment.

To Dust: Use soft, clean cloth.

---

## Warranty Service

The enjoyment of your hardware should be everlasting, which is why our products come with a limited lifetime warranty. The warranty applies to the original owner, requires a proof of purchase (hang on to your receipt!) and covers defects in material or craftsmanship. Hardware must have been properly installed. We reserve the right to determine if your hardware warrants a repair or a replacement. Visit [smithandnoble.com/guarantee](https://smithandnoble.com/guarantee) to see full details. In need of warranty service? Call us at **800.248.8888** and we'll arrange for a repair or replacement ASAP.