

SMITH & NOBLE

STEP BY STEP INSTALLATION INSTRUCTIONS

Wrought Iron Medium Hardware

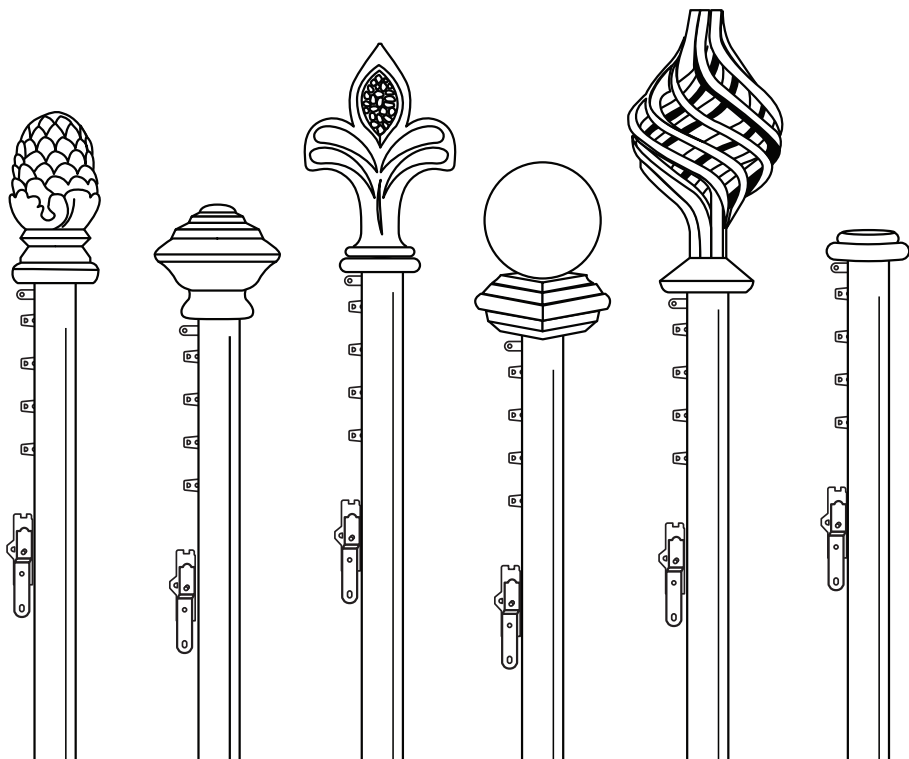

Wall Mount
Traversing
Single Rod Set

Everything You Need

A Smooth Set-Up

We want you to love your new hardware and that includes having a smooth installation experience. We recommend saving this guide. If you encounter any difficulties or questions, please reach out to us for help. It's why we're here. Call us at 800.248.8888 for more info on installation.

We recommend you hold on to all packaging until your window coverings are fully installed. Should something go wrong (we strongly doubt it), we want any potential returns to be a painless as possible.

Customer Service Hours

Monday – Friday: 6am – 6pm PT

Saturday – Sunday: 7am – 4pm PT

smithandnoble.com



Table of Contents

<i>Step 1 -</i>	Getting Started	3
<i>Overview -</i>	Wall Mount Single Rod Set Traversing	4
<i>Step 2 -</i>	Mounting the Brackets	5
<i>Step 3 -</i>	Rod Connectors	6
<i>Step 4 -</i>	Securing the Rod to Brackets	7
<i>Step 5 -</i>	Attaching the Finials	7
<i>Accessories -</i>	Tiebacks (optional)	8
	Baton/Wand (optional)	9
	Care & Cleaning and Safety	10
	Warranty	Back Cover

Getting Started

First, make sure you have all the parts and tools required to install your shades.

ALL THE HARDWARE YOU'LL NEED:

Pencil, tape measure, screwdriver, 1/8" drill bit, level, a drill with a 3/16" drill bit, a hammer.

Then find wooden studs where you'll want to attach the brackets; if you need to mount your shades to wallboard or plaster, use a secure fastener designed for hollow wall applications. For metal surfaces, pre-drill holes and use the included screws. For concrete, stone, brick, or tile surfaces, use a masonry drill and appropriate plugs, anchors, or screws.



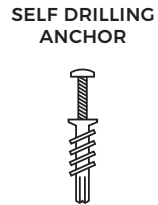





It's important when selecting a fastener to make sure it's designed to support the weight of the shade. Follow the fastener manufacturer's instruction from there on out.

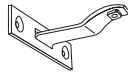

Note: It's important to monitor the amount of pressure you apply when using a drill. If the screws are too tight this may cause the screw itself to break off in the wall or window frame.

Wall Mount Single Rod Set Traversing



Parts			
 SCREWS	 SINGLE TRAVERSING BRACKET	 CENTER BRACKET	 BALL BEARING CARRIERS
 POWER DRILL (NOT INCLUDED)	 SCREW DRIVER (NOT INCLUDED)	 PENCIL (NOT INCLUDED)	 LEVEL (NOT INCLUDED)

BRACKET SCHEDULE SINGLE WALL MOUNT ROD SET

ROD QTY	BRACKET QTY	ROD WIDTH
1	2	12"–48"
1	3	48 1/8"–96"
2	5	96 1/8"–192"

Step 2 – Mounting Brackets

STEP 1:

Place the panel on the rod. To ensure it drapes at the correct length, hold it up to the spot you wish to install it. Raise or lower your treatment as desired. After you've located the ideal location, use a pencil to mark where the top of the rod is resting.

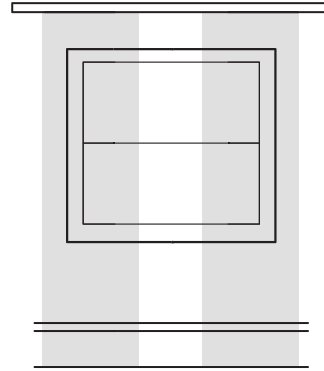

STEP 2:

Remove the panel from the rod and then center the rod over the window opening at the desired height. Using the pencil, mark where the ends of each rod are positioned; if you're using a center bracket, note the middle point between these two spots as well. If you have more than one center bracket spread these evenly between the two end brackets and center point. Measure 2" inward from the marks you've made on both ends and mark those spots. This is where the brackets will be installed.

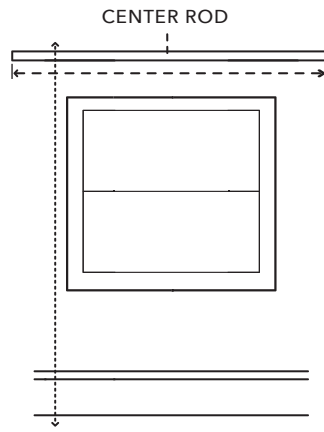

STEP 3:

Place the brackets at the marked height and then mark the location of the screw holes with your pencil. Once you've established where everything should go, put the bracket aside and double-check to make sure the pencil marks are level with each other. Next, pre-drill the holes in their assigned spot, making sure it's the right depth for the supplied screws. Install your brackets.

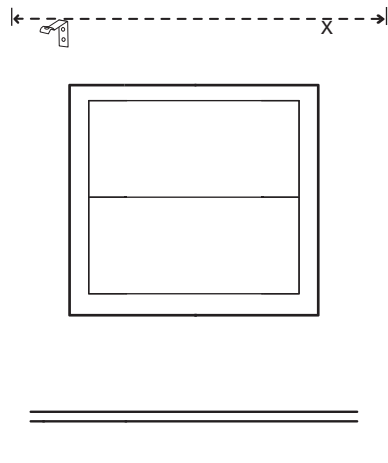

Step 3 – Attaching Rod Connector

Depending on your order, you may have received a rod connector. A rod connector is a metal piece that slides the top groove of the rods that will be connected.

STEP 1:

Slide half way the metal piece on the top groove of one of the rods and hold it in place by screwing it on with the small screws provided.

STEP 2:

Proceed to slide the other half to the other rod and repeat to screw it on as well until both rods are tightly together and there is no visible gap.

SPLICED ROD CONNECTOR

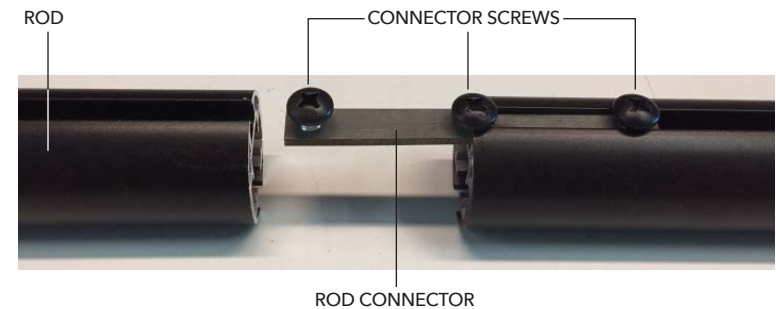

Step 4 – Securing Rod to Brackets

STEP 1:

To attach rod to brackets, loosen up the screw at top of bracket slightly, slide the rectangular metal piece in the groove on top of the track and tighten up the screw. The rectangular piece should now be perpendicular to the groove and should be tight and hold the rod to the bracket.

If your rod has center support brackets, be sure to slide those first and then slide the two end ones, one at each end.

Proceed to do the same with all brackets until they are all attached to the rod.

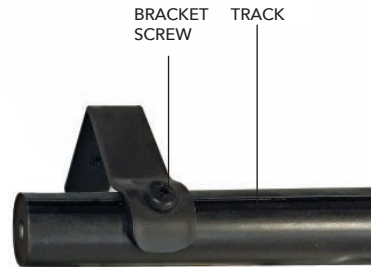

STEP 2:

If your rod came spliced, a bracket should be placed at every splice connection and the screw should go in the middle hole of the splice connector.

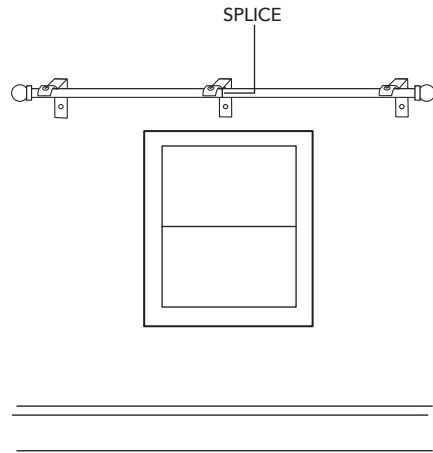

Step 5 – Attaching Finials

Finials will come with a threaded base. Simply screw the finial into the end of the rod.

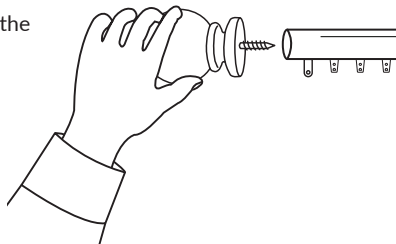

Accessories (optional)

Tiebacks (optional)

In order to locate where to install your tiebacks, measure the height of the window and divide this by two.

Using the previous calculation, mark that spot on the wall with a pencil. To ensure you like the way the panel drapes, gather one side and sweep it over to the approximate proposed location.

Once you're sure the tieback is in the perfect location, use your pencil to mark the spot to install it.

Measure the distance from the bottom or top of the window to the tieback to mark the other side and ensure they're even.

Now hold the tieback hardware on the wall at the desired location and rest a level above it, adjusting it until it's straight.

Place tieback level against wall in desired locations and lightly draw a circle around the base of the tieback onto wall, see Figure A.

Remove tieback post and cover from mounting plate.

Center mounting plate inside of the circle outline on wall.

Attach the metal mounting plate to the wall using the appropriate mounting hardware.

Place cover over the mounting plate.

Thread tieback post onto the mounting plate, see Figure B.

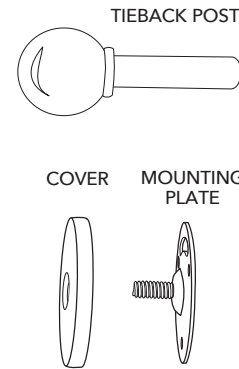

FIGURE A

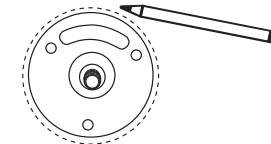
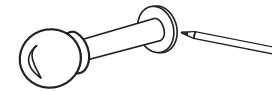
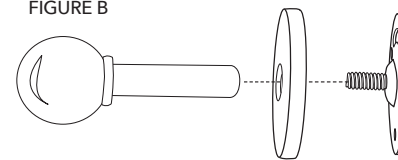
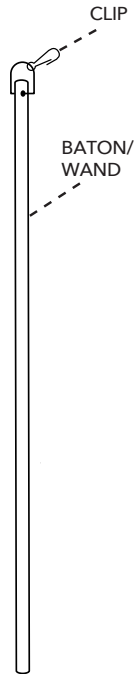

FIGURE B



Baton/Wand (optional)

After your hardware is installed, attach the baton to the second hole of the master carrier by the clip.



Care & Cleaning

Minimal care and cleaning is needed to maintain the beauty of your hardware.

To Vacuum: Use a hand-held vacuum with low suction and a soft bristle attachment for a more thorough cleaning.

To Dust: Use a feather duster to keep your shades looking fresh and neat.

Safety

Safety First. Style Second To None™.

Great style should never come at the cost of safety. Every Smith & Noble window treatment conforms strictly to today's safety standards, including permanent tie-down devices and built-in cord stops. To protect young children and pets, there's no better way to eliminate risk than to use one of our Motivia motorized products.



Warranty Service

The enjoyment of your products should be everlasting, which is why our products come with a limited lifetime warranty. The warranty applies to the original owner, requires a proof of purchase and covers defects in material or craftsmanship. Shades, blinds or hardware must have been properly installed. We reserve the right to determine if your window covering warrants a repair or a replacement. In need of warranty service? Call us at 800.248.8888 and we'll arrange for a repair or replacement ASAP.
