

SMITH & NOBLE

STEP BY STEP INSTALLATION INSTRUCTIONS

Cosmopolitan Grand Hardware

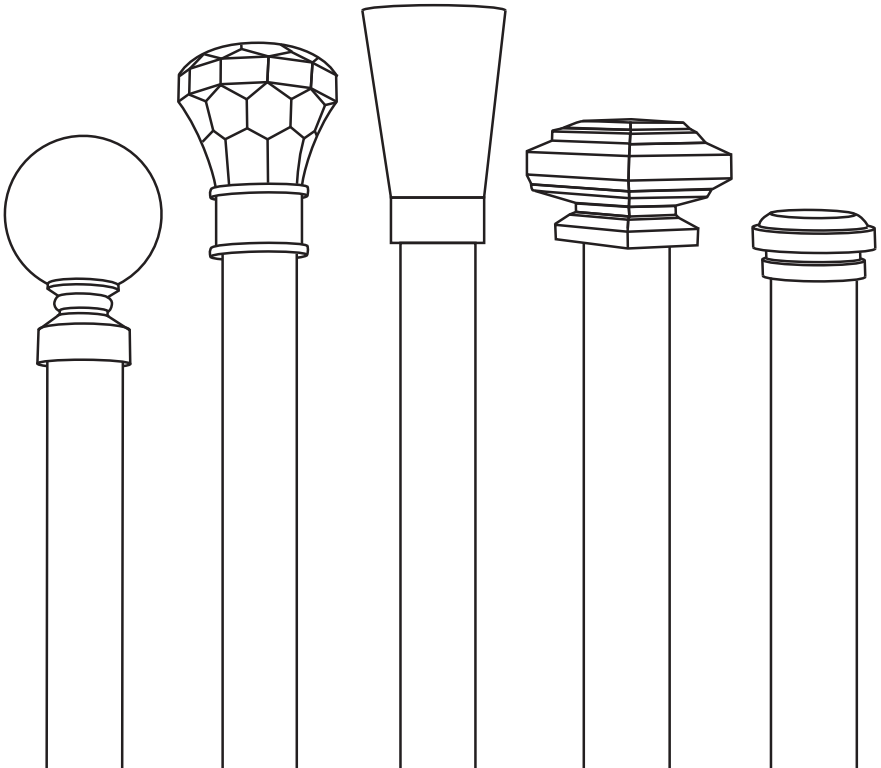

Wall Mount
Single Rod Set

Everything You Need

A Smooth Set-Up

We want you to love your new hardware and that includes having a smooth installation experience. We suggest saving this guide. If you encounter any difficulties or questions, please reach out to us for help. It's why we're here. Call us at **800.248.8888** for more info on installation.

We recommend you hold on to all packaging until your hardware is fully installed. Should something go wrong (we strongly doubt it), we want any potential returns to be a painless as possible.

Customer Service Hours

Monday – Friday: 6am – 6pm PT

Saturday – Sunday: 7am – 4pm PT

smithandnoble.com



Table of Contents

<i>Step 1 -</i>	Getting Started	3
<i>Overview -</i>	Wall Mount Single Rod Set	4
	Attaching Ring Hook to Ring	4
<i>Step 2 -</i>	Mounting the Brackets	5
<i>Step 3 -</i>	Attaching the Rod Connector	6
<i>Step 4 -</i>	Attaching the Finials	7-9
<i>Step 5 -</i>	Securing Rod to Brackets	9
<i>Accessories -</i>	Tiebacks (optional)	10
	Baton/Wand (optional)	10
Care & Cleaning		Back Cover
Warranty		Back Cover

Getting Started

Before you begin, check the accompanying diagram to make sure you have all the parts you need. You'll need to make sure the surface you intend to install your hardware is sturdy enough to accommodate the brackets. If you're screwing directly into a surface this means locating wood studs that are strong enough to securely bond with the included screws. Otherwise, you'll need to use a secure fastener (as illustrated) but please note this piece is not included.

WALLBOARD OR PLASTER:

Hollow wall applications: Use a secure fastener designed specifically for this purpose.



METAL:

Prepare by pre-drilling holes and then using the included screws.



CONCRETE, STONE, BRICK OR TILE:

Use a masonry drill and surface-specific plugs, anchors, or screws. When selecting a fastener be sure it's designed to support the weight of the product being installed (if you're not sure, either give us a call or ask a professional at your local hardware store). Once obtained, follow the fastener manufacturer's instructions regarding proper installation.

TOOLS YOU WILL NEED TO INSTALL YOUR HARDWARE:

Pencil, screwdriver, 1/4" nut driver, level, and a drill with a 7/64" drill bit.

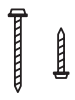
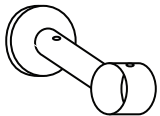
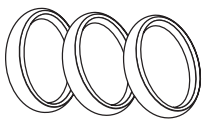
Note: It's important to monitor the amount of pressure you apply when using a drill. If the screws are too tight this may cause the screw itself to break off in the wall or window frame.

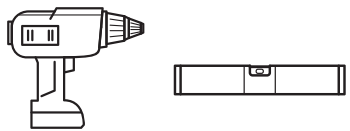
 SCREWS	 SUPPORT BRACKET
 RINGS	 RING HOOKS
 PENCIL & SCREWDRIVER (NOT INCLUDED)	 POWER DRILL & LEVEL (NOT INCLUDED)

Cosmopolitan Grand Single Rod Set

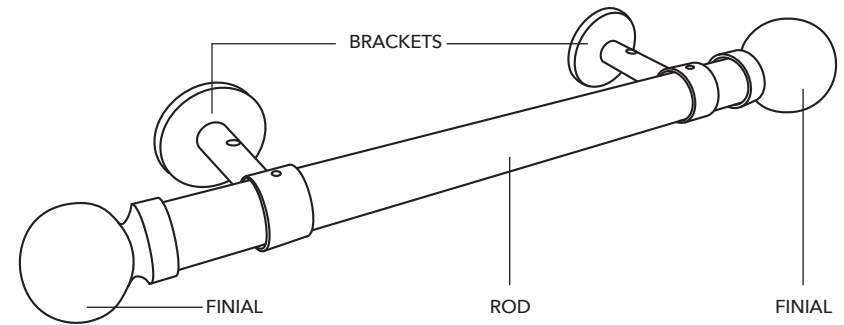

ROD QTY	BRACKET QTY	ROD WIDTH
1	2	12"–72"
1	3	72 1/8"–96"
2	5	96 1/8"–204"
3	7	204 1/8"–288"
3	10	288 1/8"–312"
4	10	312 1/8"–384"

Attach Ring Hook to Ring

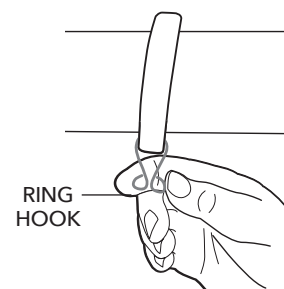

Place a ring hook on the ring and squeeze both ends of ring hook together so that the two holes are on top of each other.

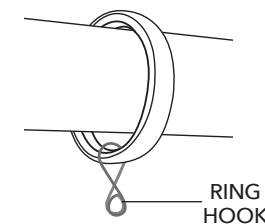

Mounting the Brackets

STEP 1:

Place the panel on the rod. To ensure it drapes at the correct length, hold it up to the spot you wish to install it; this will allow you to raise or lower your treatment as desired. After you've located the ideal location, use a pencil to mark the wall where the top of the rod is resting.

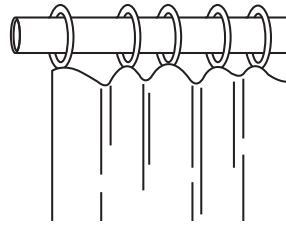

STEP 2:

Remove the panel from the rod and then center the rod over the window opening at the desired height. Using the pencil, mark where the ends of each rod are positioned; if you're using a center bracket, note the middle point between these two spots as well. Measure 2" inward from the marks you've made on both ends and mark those spots. This is where the brackets will be installed.

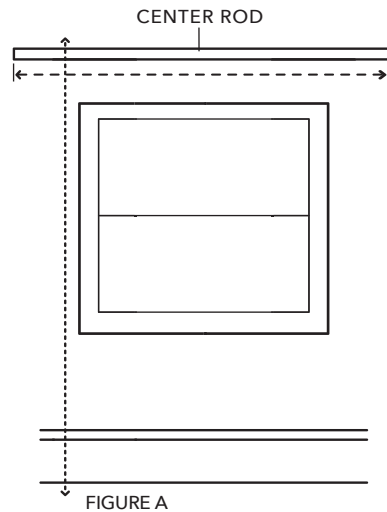

STEP 3:

Place bracket level against wall at the marked spots. Using a pencil, lightly draw a circle around the base of the bracket onto wall, see Figure A.

Check to make sure the circles are level & aligned with each other.

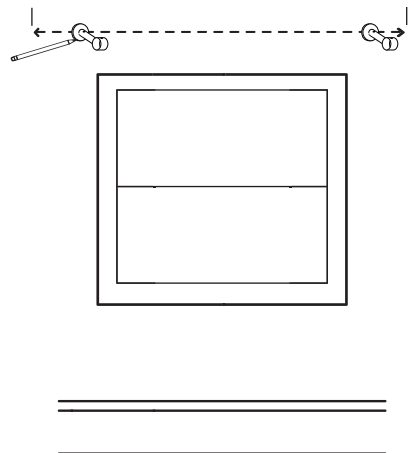
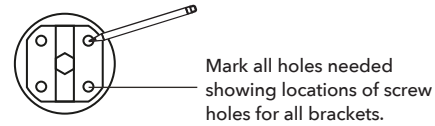

FIGURE B



Mark all holes needed showing locations of screw holes for all brackets.

Remove mounting plate and center it inside of the circle outline on wall. Mark the screw hole locations for all brackets. See Figure B.

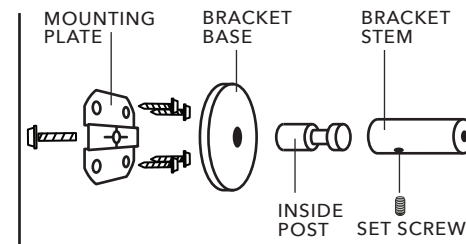

FIGURE C
Place bracket base on top of mounting plate and thread in the inside post and tighten all the way.

FIGURE D
Insert bracket stem into inside post and secure with set screw.

Attach the metal mounting plate to the wall, aligning the holes in the plate with the marks made in the previous step, see figure B. Be sure and attach the plate to the wall with the appropriate mounting hardware. (It is always recommended to try and attach to the wood studs inside the wall. Where this is not possible please use a wall anchor suitable to carry the weight of your hardware selection as well as your draperies and any accessories.)

Step 3 - Attaching the Rod Connector

Rod Connector

Depending on your order, you may have received a rod connector. A rod connector is the short piece of metal tubing placed inside each end of the rods in a multi-segment system to join them together.

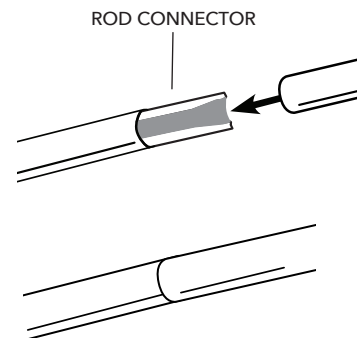
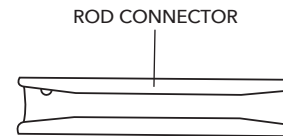

STEP 1:

On the open end of one-rod segment, slide the connector halfway inside, leaving the other half exposed.

STEP 2:

Now slide the second rod segment over the exposed end of the connector, making sure there is no gap between the two segments.

Attaching Finials & Hinged Elbow

STEP 1:

For treatments using rings and do not have a center support bracket

Insert the rod through the first bracket and then place the required number of rings on the rod but leave two rings out. Then slide the rod through the second bracket. All the rings should now be in between the two brackets. For split drapery, add a ring at each end of the rod and then attach the finial. *See Page 9 Attaching Finials.*

This will prevent drapery to be pulled all the way to one side or the other when opening and closing it. If you are opening your drapery only from one side, leave one ring between the finial and bracket on the side you won't be opening it from.

For treatments using rings and have a center support bracket

Insert the rod through the end and center support bracket. Before inserting it through the last bracket, place half of the required number of rings on the rod but leave two rings out. Then slide the rod through the last end bracket.

Go back to the opposite side and take the rod out of the end bracket to allow you to place the remaining of the rings minus two of them. All the rings should now be in between the two end brackets and center

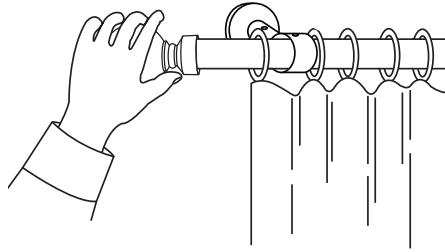

support bracket. For split drapery, add a ring at one end of the rod and then attach the finial. *See Page 9 Attaching Finials.*

This will prevent drapery to be pulled all the way to one side or the other when opening and closing it. If you are opening your drapery only from one side, leave one ring between the finial and bracket on the side you won't be opening it from.

For treatments without rings and no center support bracket

Attach the finial to one end of the rod, and slide it through the first bracket.

Position the drapery panel on the rod, and then slide it through the last bracket.

Cap the opposite end with the second finial.

For treatments without rings and a center support bracket

Attach the finial to one end of the rod, and slide it through the first bracket.

Position one of the drapery panels on the rod, and then slide the rod through the center support bracket.

Position the other drapery panel on the rod, and then slide the rod through the last support bracket. Cap the opposite end with the second finial.

Step 4 - Attaching Finials

STEP 2:

To attach most of the finials, place the finial on the tube and attach it using the set screw. See Fig 1.

For the Beveled Square Finial, it comes with a threaded base. Simply screw the finial into the end of the rod. See Fig. 2

Repeat attaching the finial to the opposite side.

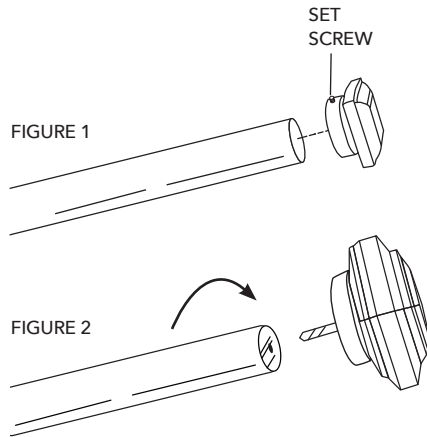

Accessories

Baton/Wand (optional)

After your hardware is installed, attach the baton to the eyelet of the first ring by the clip.

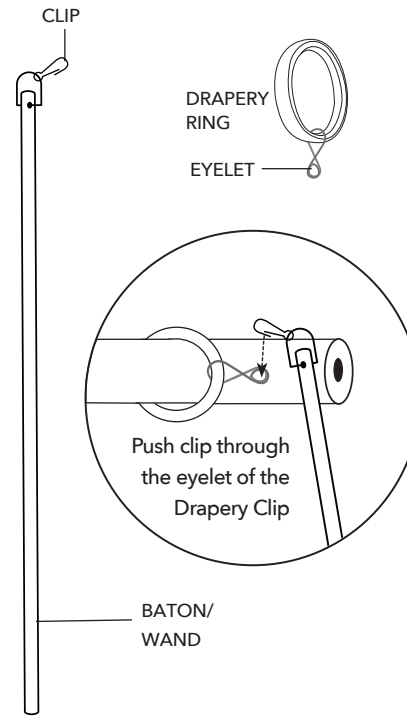

Tiebacks (optional)

STEP 1

In order to locate where to install your tiebacks, measure the height of the window and divide this by two. Using the previous calculation, mark that spot on the wall with a pencil. To ensure you like the way the panel drapes, gather one side and sweep it over to the approximate proposed location. Once you're sure the tieback is in the perfect location, use your pencil to mark the spot to install it. Measure the distance from the bottom or top of the window to the tieback to mark the other side and ensure they're even. Now hold the tieback hardware on the wall at the desired location and rest a level above it, adjusting it until it's straight.

STEP 2

Place tieback level against wall in the desired location and attach to the wall. Repeat for next one, if you are using multiple tiebacks.

Step 5 - Securing Rod to Brackets

Securing Rod to Brackets

STEP 1:

Once the rod had been placed on the brackets, secure the rod in place by tightening the bracket set screw.

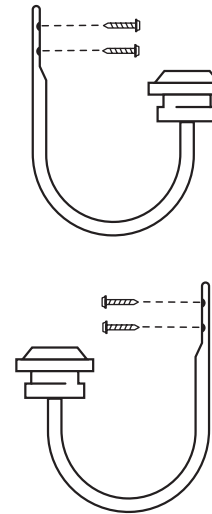
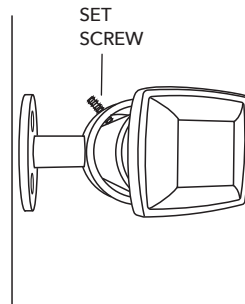

Care & Cleaning

Care & Cleaning

Minimal care and cleaning is needed to maintain the beauty of your Hardware.

To Vacuum: Use brush or dust head attachment.

To Dust: Use soft, clean cloth.

Warranty Service

The enjoyment of your hardware should be everlasting, which is why our products come with a limited lifetime warranty. The warranty applies to the original owner, requires a proof of purchase (hang on to your receipt!) and covers defects in material or craftsmanship. Hardware must have been properly installed. We reserve the right to determine if your hardware warrants a repair or a replacement. Visit smithandnoble.com/guarantee to see full details. In need of warranty service? Call us at 800.248.8888 and we'll arrange for a repair or replacement ASAP.
