

SMITH & NOBLE

STEP BY STEP INSTALLATION INSTRUCTIONS

Bay Window Valance

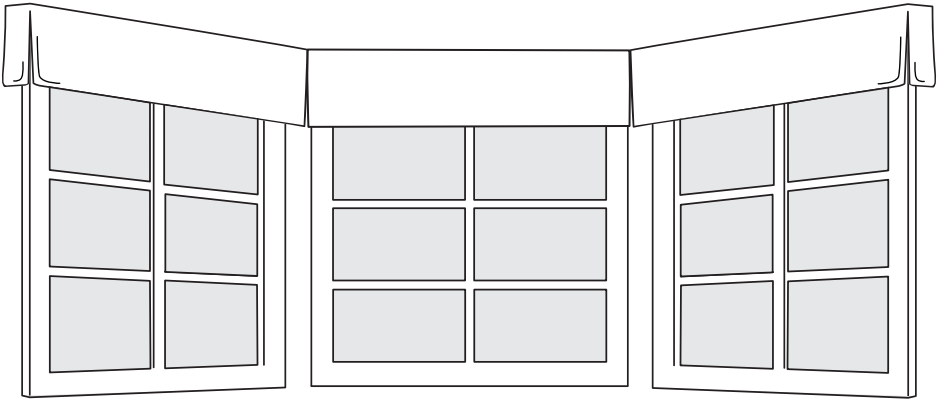

Wall Mount

Everything You Need

A Smooth Set-Up

We want you to love your new window coverings and that includes having a smooth installation experience. If you encounter any difficulties or questions, please reach out to us for help. It's why we're here. Call us at 800.248.8888 or visit www.smithandnoble.com/knowhow for more info on installation.

We recommend you hold on to all packaging until your window coverings are fully installed. Should something go wrong (we strongly doubt it), we want any potential returns to be a painless as possible.

Customer Service Hours

Monday – Friday: 6am – 7pm PT

Saturday – Sunday: 7am – 4pm PT

smithandnoble.com



Table of Contents

<i>Step 1 -</i>	Getting Started	3
<i>Overview -</i>	4
<i>Step 2 -</i>	Mounting the Brackets	5
<i>Step 3 -</i>	Attaching Rod & Hanging Valance	6
	Care & Cleaning Instructions	6
	Warranty.....	Back Cover

Getting Started



First, make sure you have all the parts and tools required to install your valance.

ALL THE HARDWARE YOU'LL NEED:

Pencil, screw-driver, ¼" nut driver, level, and a drill with a ⅛" drill bit.

Then find wooden studs where you'll want to attach the brackets; if you need to mount your valance to wallboard or plaster, use a secure fastener designed for hollow wall applications. For metal surfaces, pre-drill holes and use the included screws. For concrete, stone, brick, or tile surfaces, use a masonry drill and appropriate plugs, anchors, or screws.

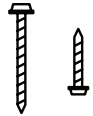
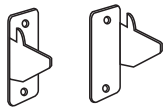
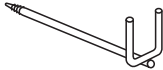
It's important when selecting a fastener to make sure it's designed to support the weight of the shade. Follow the fastener manufacturer's instruction from there on out.

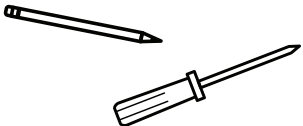
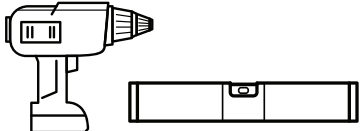
 <p>SCREWS (4)</p>	 <p>BRACKETS: LEFT AND RIGHT</p>
 <p>SUPPORTS HOOKS (2)</p>	 <p>THREADER (3)</p>
 <p>PENCIL & SCREWDRIVER (NOT INCLUDED)</p>	 <p>POWER DRILL & LEVEL (NOT INCLUDED)</p>

Bay Window Curtain Rod

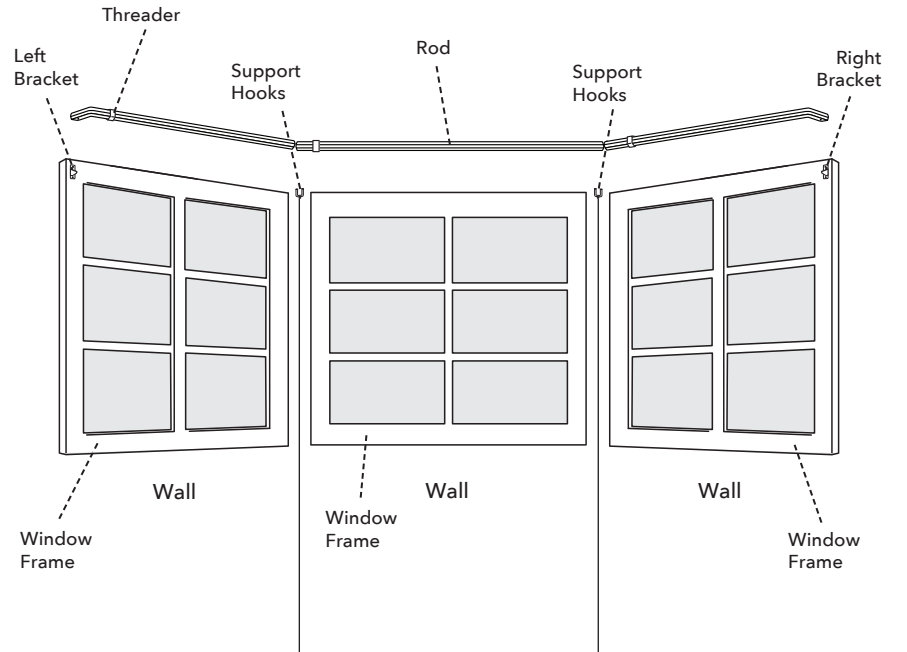

Step 2 – Mounting Brackets

Mount Brackets

Determine the height that you want to mount the valance at. The valance will mount with two brackets, one at each end, and two support hooks, one in each corner. Screw the support hooks into the corners of the bay window at the height you want to mount the valance at. When mounted the prongs on the support hooks should be facing up. Hold the left end bracket at the spot where you will be mounting it. The bottom hole of the bracket should be at the same height as the bottom of the support hooks. Mark the bottom hole in the bracket with a pencil. Repeat this process with the right end bracket. Mount both end brackets using the screws provided. Make sure they are at the same height.

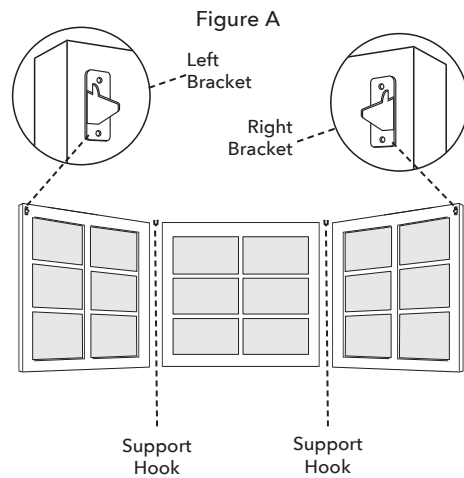

Step 3 – Attaching Rods & Hanging Valance

Attaching Rods & Hanging Valances

Put the Threader over the end of the large rod section. Attach the valance to the left rod by slipping the rod through the tabs on the backside of the valance. Once the valance is on the left rod, attach the rod to the left bracket and support hook. Put the top hole of the left rod over the prong on the left bracket and then swing the rod down into place. Attach the holes on the other end of the rod to the prong on the support bracket. Thread the center rod through the tabs on the back of the valance and attach the holes at each end of the rod onto the prongs of the support brackets. Lastly slip the rest of the tabs on the valance through the right side rod and attach it just like the left rod.

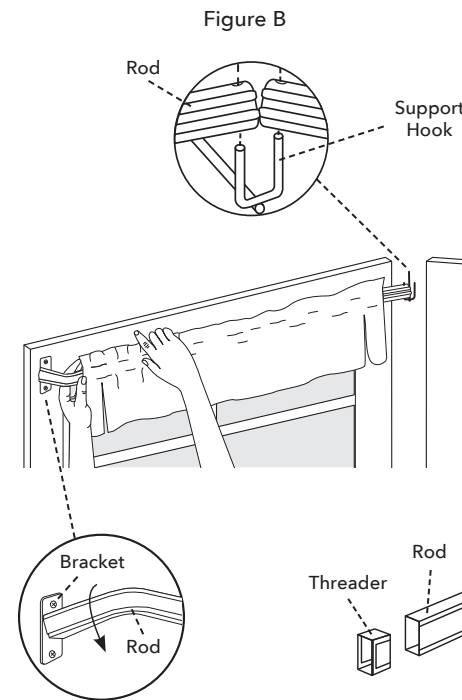

Care & Cleaning

Care & Cleaning

Use brush or dust head attachment. Occasional light vacuuming with a soft bristle attachment or gentle feather dusting is all that is required to keep your valance looking fresh and neat.

Warranty Service

The enjoyment of your window coverings should be everlasting, which is why our products come with a limited lifetime warranty. The warranty applies to the original owner, requires a proof of purchase and covers defects in material or craftsmanship. Shades or blinds must have been properly installed. We reserve the right to determine if your window covering warrants a repair or a replacement. In need of warranty service? Call us at 800.248.8888 and we'll arrange for a repair or replacement ASAP.
